



现代主义艺术。表面结构精湛美观，坚固耐用。精致的轮廓勾勒出极致的细节。人体工程学的运用，带来美妙的握持感。匠心独运，成就卓越之作。型臻于美，造就家居瑰宝。

Modernist Art. The structure is exquisite and beautiful, firm and durable. The delicate contours, the exquisite detail. The use of Ergonomics, bring a wonderful sense of grip. A masterpiece of ingenuity. Perfect in shape, bring up household treasures.

从锻造、车削、压铸、研磨、振动、抛光镜面处理，再到镀铬，金属化（PVD）及上光工艺处理等全流程，美拓始终保持匠心，以严苛态度把关。这份对细节的关注，也正是美拓锁具产品脱颖而出的原因。

From forging, turning, die-casting, grinding, vibration, polishing mirror treatment, to chrome plating, metallization (PVD) and polishing process, etc. . This attention to detail is what makes the company's locks stand out.

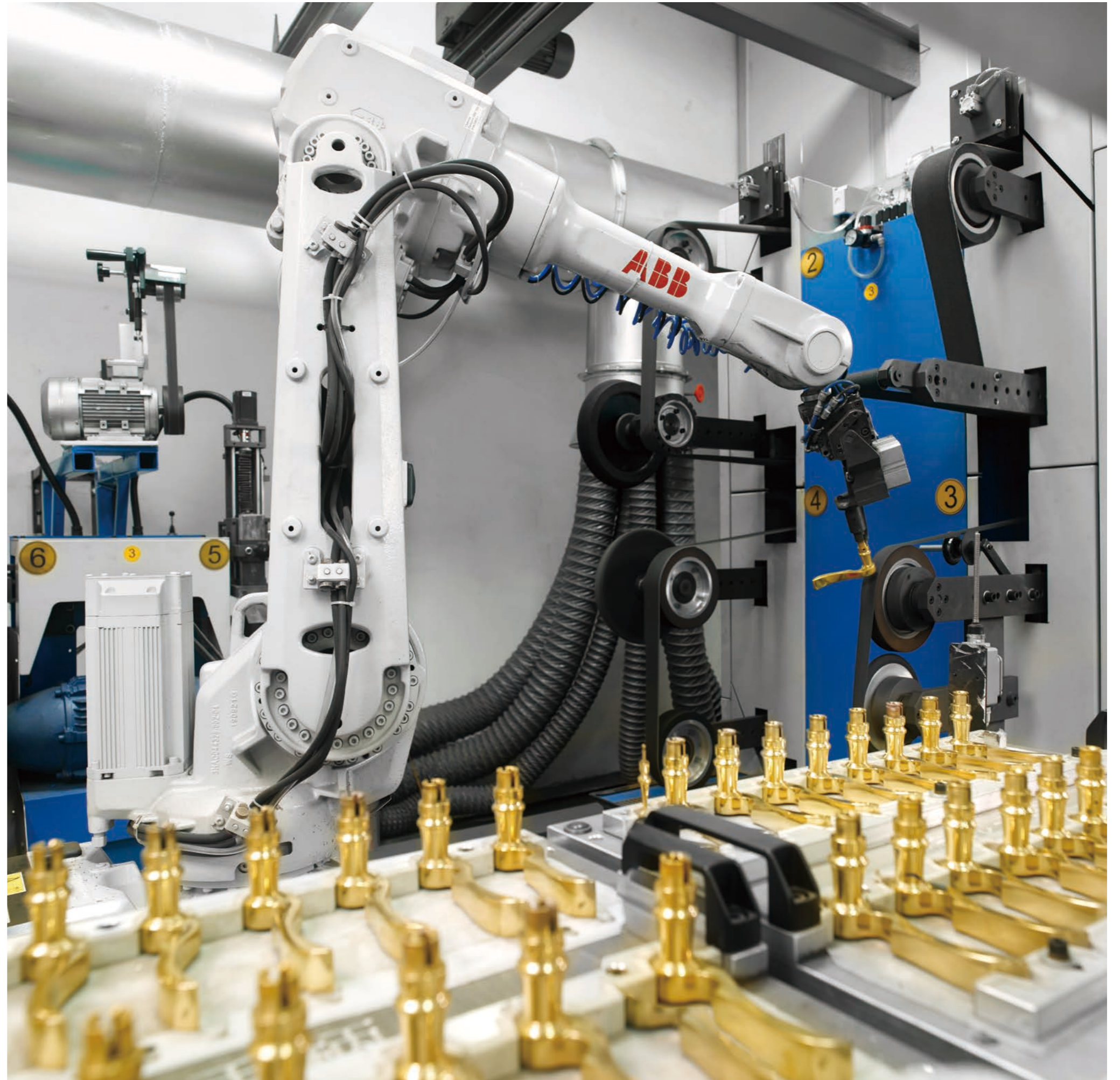





现代化全自动电脉流水线采用世界最新表面处理工艺技术，品质优良且高度环保。

The modern automatic electric pulse line adopts the latest surface treatment technology in the world, with high quality and high environmental protection.

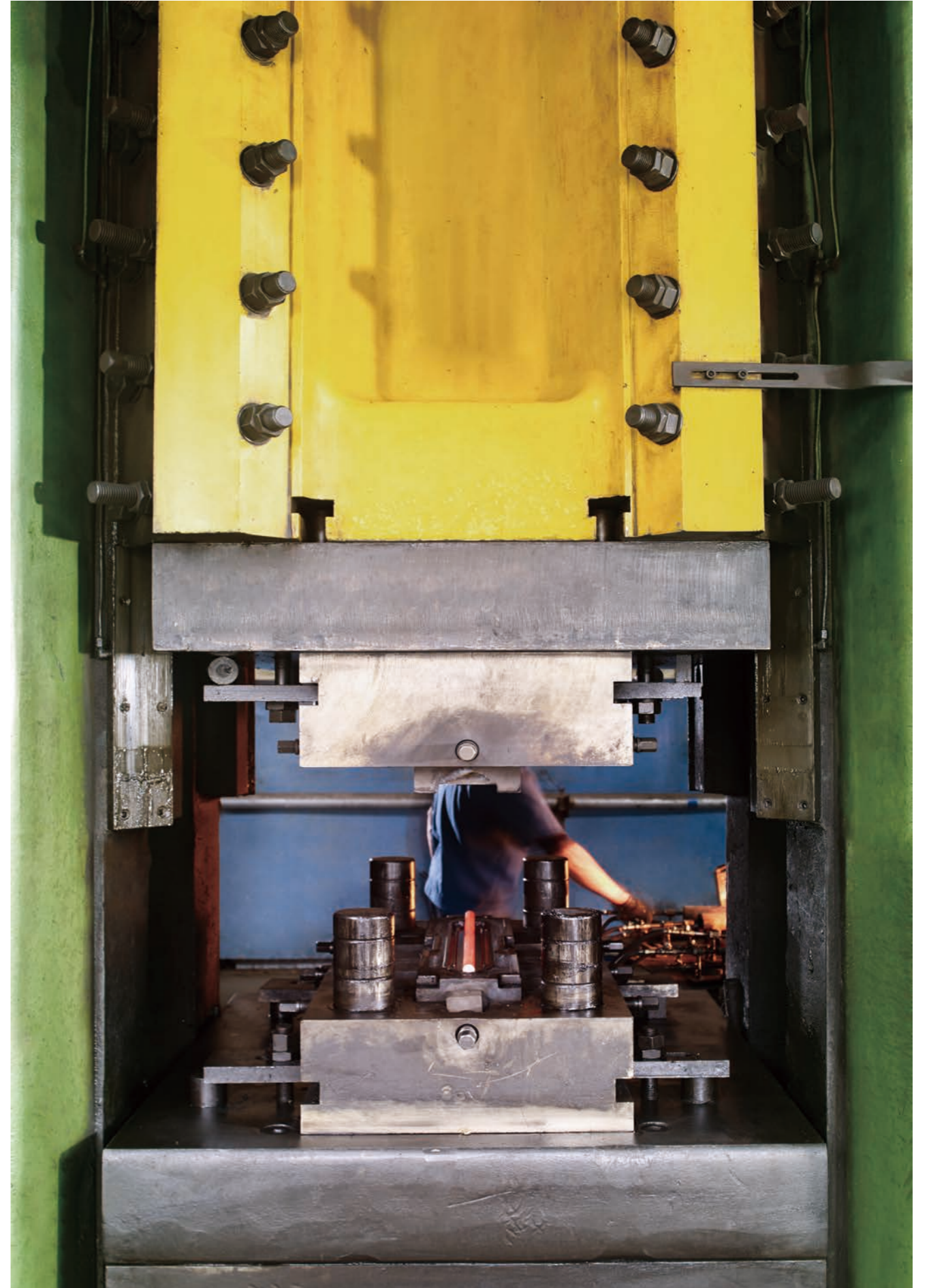

配备了全自动抛光流水线，涵盖外表清理、打磨、抛光防腐处理等重要工艺，充分保证产品光亮色泽、耐腐蚀、耐污染的特性。在全自动抛光工序后，通过人工对每个产品进行一一检测，任何一点小瑕疵都不放过，比机械检测更加细致。

equipped with automatic polishing assembly line, covering the appearance cleaning, polishing, polishing anti-corrosion treatment and other important processes, fully guarantee the product bright color, corrosion resistance, anti-pollution characteristics. After the automatic polishing process, each product is tested manually, and every small defect is not missed, which is more careful than mechanical testing.



DOOR LOCK 门锁

以精简的设计风格为重点，在简洁的线条和清晰的功能中体现去繁从简的设计，摒弃冗余，一切简单明了。

Focus on simple design style, in the simple lines and clear functions to reflect the design, eliminate redundancy, all simple and clear.



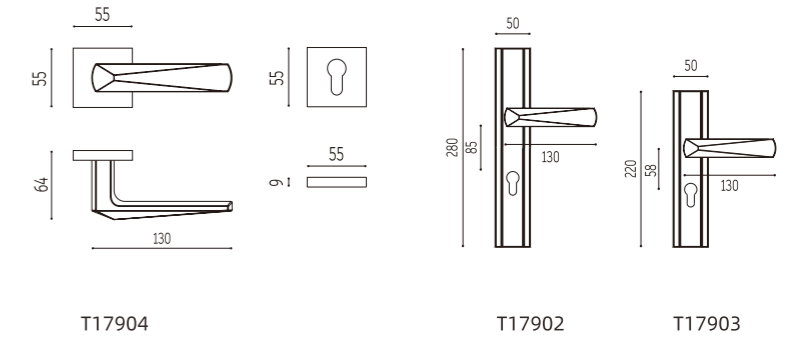

产品型号 T17904 565
产品材质 纯铜
表面处理 亚黑



产品型号 T17904 566
产品材质 纯铜
表面处理 卡其灰



产品型号 T17904 305
产品材质 纯铜
表面处理 咖啡古铜



产品型号 T17904 563
产品材质 纯铜
表面处理 黑古金



产品型号 T17904 533
产品材质 纯铜
表面处理 法国黄古铜



产品型号 T17902 565
产品材质 纯铜
表面处理 亚黑



产品型号 T17902 566
产品材质 纯铜
表面处理 卡其灰



产品型号 T17902 305
产品材质 纯铜
表面处理 咖啡古铜

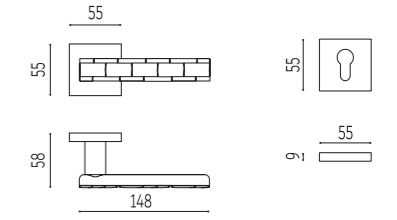

产品型号 A801-001 305
产品材质 纯铜
表面处理 咖啡古铜



产品型号 A801-001 533
产品材质 纯铜
表面处理 法国黄古铜



产品型号 A801-001 535
产品材质 纯铜
表面处理 亚漆不擦红

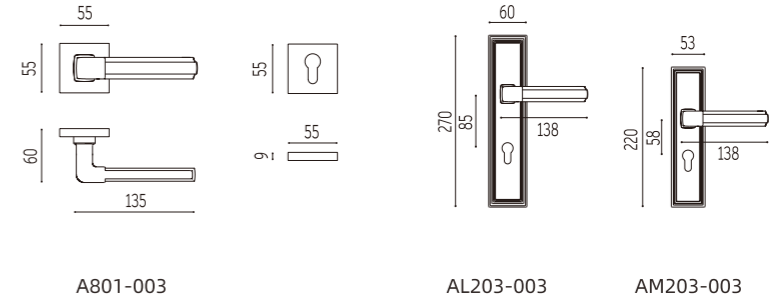
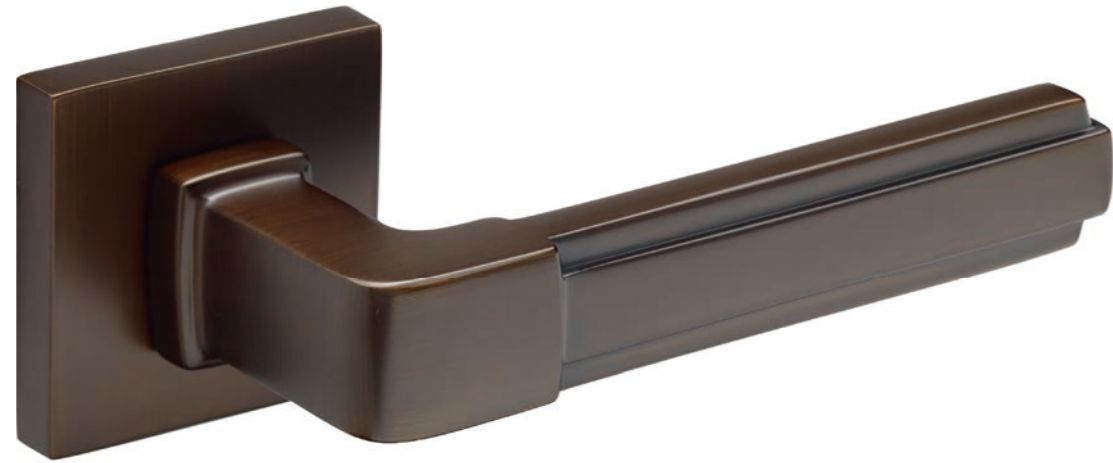

产品型号 A801-003 565
产品材质 纯铜
表面处理 亚黑



产品型号 A801-003 561
产品材质 纯铜
表面处理 摩卡棕



产品型号 A801-003 305
产品材质 纯铜
表面处理 咖啡古铜



产品型号 A801-003 533
产品材质 纯铜
表面处理 法国黄古铜



产品型号 A801-003 535
产品材质 纯铜
表面处理 亚漆不擦红



产品型号 AL203-003 565
产品材质 纯铜
表面处理 亚黑



产品型号 AL203-003 561
产品材质 纯铜
表面处理 摩卡棕



产品型号 AL203-003 305
产品材质 纯铜
表面处理 咖啡古铜

还有什么比我们的美拓当代门把手更好的进入房间的方式呢？符合人体工程学的完美设计，恰到好处的曲线，它们的形体和优雅都汇聚成一件漂亮的艺术品。

What better way to make an entrance to a room than with our stunning Amertop contemporary door handles. Ergonomically perfect and with curves in all the right places, it's substance and elegance all rolled into one beautiful piece of door furniture.

24



ELEGANT

优雅
律动曲线在生活的转角处
优雅的绽放



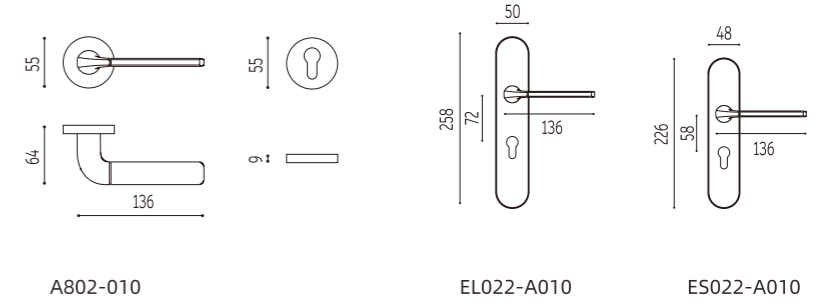

A802-010

EL022-A010

ES022-A010



产品型号 A802-010 565
 产品材质 纯铜
 表面处理 亚黑



产品型号 A802-010 561
 产品材质 纯铜
 表面处理 摩卡棕



产品型号 A802-010 536
 产品材质 纯铜
 表面处理 皓金



产品型号 A802-010 533
 产品材质 纯铜
 表面处理 法国黄古铜



产品型号 A802-010 901
 产品材质 纯铜
 表面处理 沙丁铜



产品型号 EL022-A010 565
 产品材质 纯铜
 表面处理 亚黑



产品型号 EL022-A010 561
 产品材质 纯铜
 表面处理 摩卡棕



产品型号 EL022-A010 533
 产品材质 纯铜
 表面处理 法国黄古铜

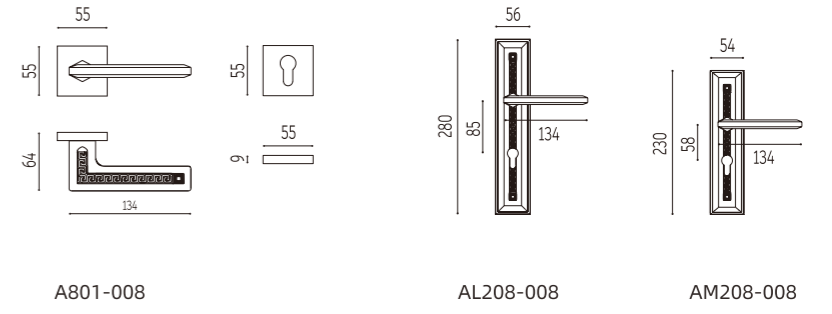

产品型号 A801-008 563
产品材质 纯铜
表面处理 黑古金



产品型号 A801-008 305
产品材质 纯铜
表面处理 咖啡古铜



产品型号 A801-008 533
产品材质 纯铜
表面处理 法国黄古铜



产品型号 AL208-008 563
产品材质 纯铜
表面处理 黑古金



产品型号 AL208-008 305
产品材质 纯铜
表面处理 咖啡古铜



产品型号 AL208-008 564
产品材质 纯铜
表面处理 古典金

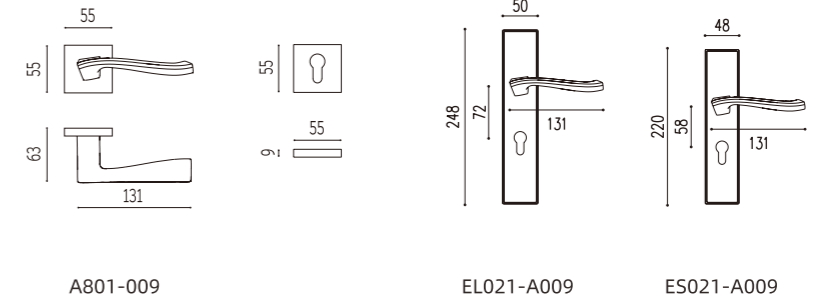

A801-009

EL021-A009

ES021-A009



产品型号 A801-009 565
 产品材质 纯铜
 表面处理 亚黑



产品型号 A801-009 566
 产品材质 纯铜
 表面处理 卡其灰



产品型号 A801-009 561
 产品材质 纯铜
 表面处理 摩卡棕



产品型号 A801-009 533
 产品材质 纯铜
 表面处理 法国黄古铜



产品型号 A801-009 901
 产品材质 纯铜
 表面处理 沙丁铜



产品型号 A801-009 103
 产品材质 纯铜
 表面处理 镀铬



产品型号 EL021-A009 565
 产品材质 纯铜
 表面处理 亚黑



产品型号 EL021-A009 566
 产品材质 纯铜
 表面处理 卡其灰



产品型号 EL021-A009 561
 产品材质 纯铜
 表面处理 摩卡棕

THE PERSPECTIVE OF FUTURE FASHION HOME

站在未来时尚家居视角，重塑或延伸时尚元素。在规则与放逐间演绎极致自由，以不凡设计为家居注入别致格调。

from the perspective of future fashion home. Reshape or extend fashion elements. The ultimate freedom between rules and exile. Inject unique style into the home with extraordinary design.



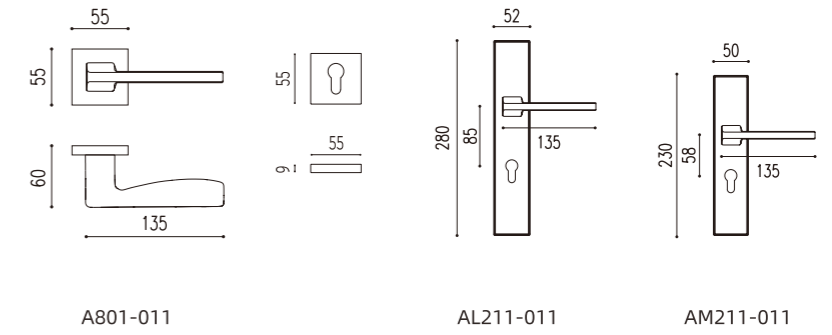
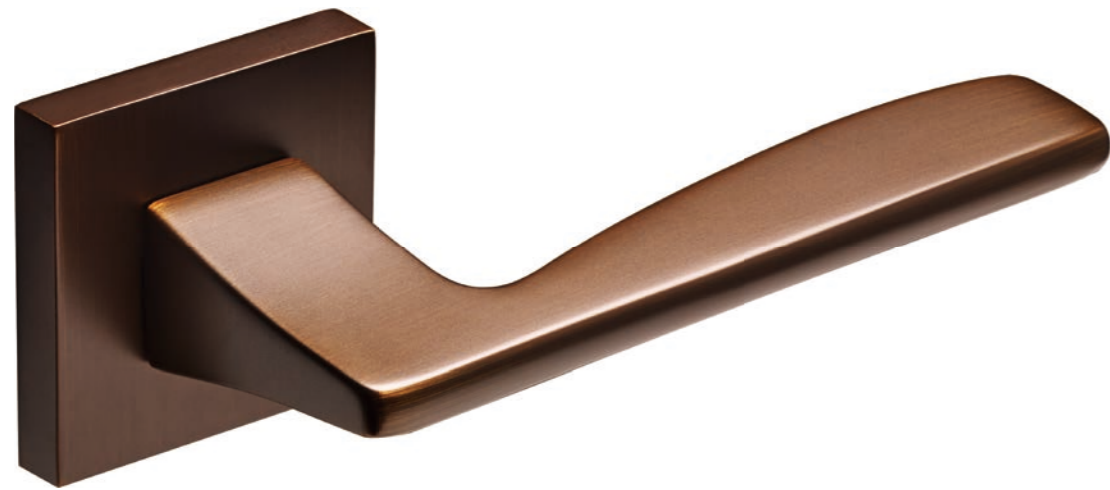

产品型号 A801-011 565
产品材质 纯铜
表面处理 亚黑



产品型号 A801-011 561
产品材质 纯铜
表面处理 摩卡棕



产品型号 A801-011 533
产品材质 纯铜
表面处理 法国黄古铜



产品型号 A801-011 901
产品材质 纯铜
表面处理 沙丁铜



产品型号 A801-011 536
产品材质 纯铜
表面处理 锆金



产品型号 A801-011 202
产品材质 纯铜
表面处理 PVD 镍



产品型号 AL211-011 565
产品材质 纯铜
表面处理 亚黑



产品型号 AL211-011 561
产品材质 纯铜
表面处理 摩卡棕



产品型号 AL211-011 901
产品材质 纯铜
表面处理 沙丁铜

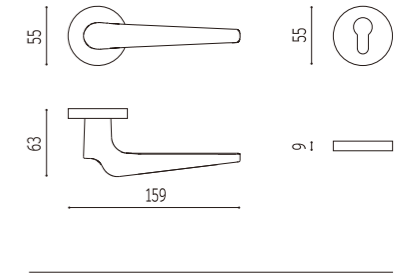

产品型号 A802-018 305
产品材质 纯铜
表面处理 咖啡古铜



产品型号 A802-018 533
产品材质 纯铜
表面处理 法国黄古铜



产品型号 A802-018 536
产品材质 纯铜
表面处理 镀金



产品型号 A802-018 202
产品材质 纯铜
表面处理 PVD 镍

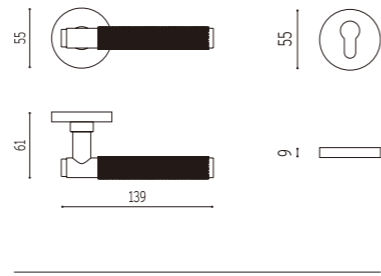

产品型号 A802-021 565
产品材质 纯铜
表面处理 亚黑



产品型号 A802-021 563
产品材质 纯铜
表面处理 黑古金



产品型号 A802-021 533
产品材质 纯铜
表面处理 法国黄古铜

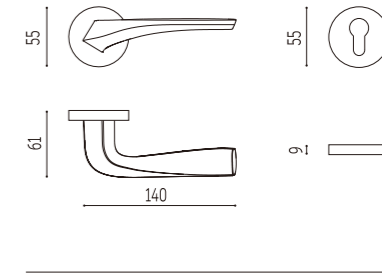

产品型号 A802-E001 566
产品材质 纯铜
表面处理 卡其灰



产品型号 A802-E001 563
产品材质 纯铜
表面处理 黑古金



产品型号 A802-E001 901
产品材质 纯铜
表面处理 沙丁铜

NATURAL CREATION

自然造物，不拘一格

每一种铜制品都演变出，独一无二的质地。
美拓每一副执手都拥有自己的语言，优雅别致的造型
设计及鲜明的配色。成为空间里的吸睛之隅，选用优
质黄铜，不惜成本用料，带来极致舒适的握感体验。

Every kind of copper product has evolved, Unique
texture. Amertop every door handle lever has its own
language. Elegant and chic design and bright colors.
Become the eye-catching corner of the space
Use high-quality brass. Use materials at any cost, Bring
an extremely comfortable grip experience.



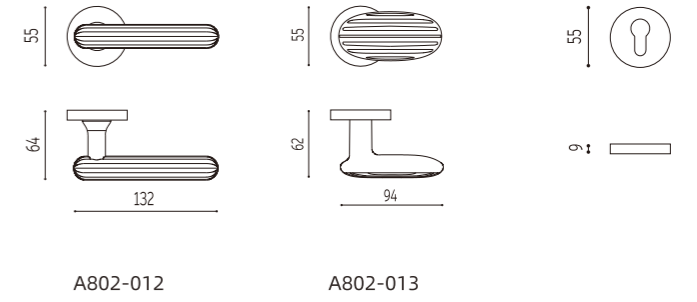

产品型号 A802-012 565
产品材质 纯铜
表面处理 亚黑



产品型号 A802-012 305
产品材质 纯铜
表面处理 咖啡古铜



产品型号 A802-012 536
产品材质 纯铜
表面处理 鎏金



产品型号 A802-013 565
产品材质 纯铜
表面处理 亚黑



产品型号 A802-013 305
产品材质 纯铜
表面处理 咖啡古铜



产品型号 A802-013 536
产品材质 纯铜
表面处理 鎏金

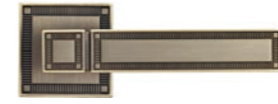
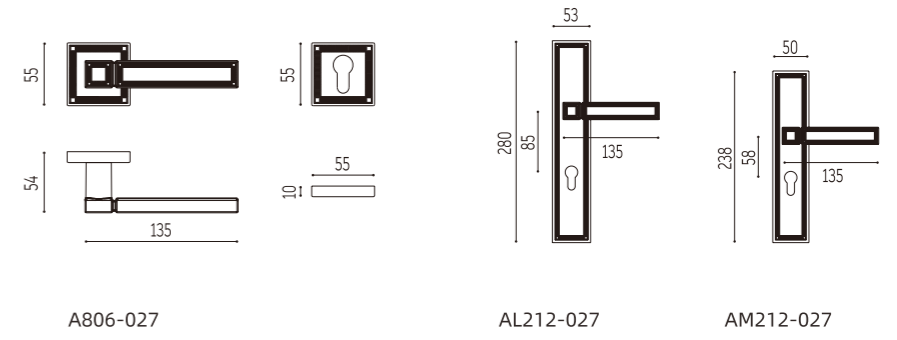

产品型号 A806-027 305
产品材质 纯铜
表面处理 咖啡古铜



产品型号 A806-027 564
产品材质 纯铜
表面处理 古典金

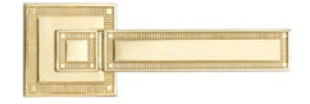

产品型号 A806-027 211
产品材质 纯铜
表面处理 真金



产品型号 AL212-027 305
产品材质 纯铜
表面处理 咖啡古铜



产品型号 AL212-027 564
产品材质 纯铜
表面处理 古典金



产品型号 AL212-027 211
产品材质 纯铜
表面处理 真金

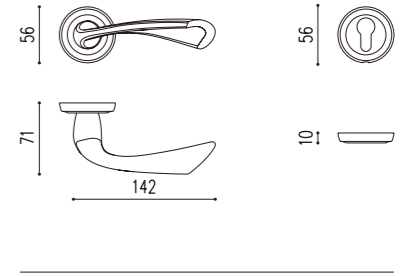

产品型号 A805-E002 565
 产品材质 纯铜
 表面处理 亚黑



产品型号 A805-E002 566
 产品材质 纯铜
 表面处理 卡其灰



产品型号 A805-E002 561
 产品材质 纯铜
 表面处理 摩卡棕



产品型号 A805-E002 901
 产品材质 纯铜
 表面处理 沙丁铜

ART LIFE

不只是一款执手，它带着自然的期许和得知有幸的欢愉，让你在轻抚的同时，找到了自己人生的位置。

Not just a handle, It comes with natural expectations, And the joy of knowing that fortunately. Let you caress at the same time. Found my place in life.



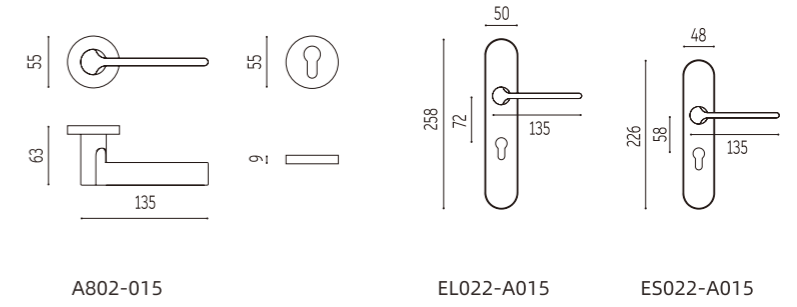

产品型号 A802-015 565
产品材质 纯铜
表面处理 亚黑



产品型号 A802-015 566
产品材质 纯铜
表面处理 卡其灰



产品型号 A802-015 561
产品材质 纯铜
表面处理 摩卡棕



产品型号 A802-015 533
产品材质 纯铜
表面处理 法国黄古铜



产品型号 A802-015 901
产品材质 纯铜
表面处理 沙丁铜



产品型号 A802-015 202
产品材质 纯铜
表面处理 PVD 镍



产品型号 EL022-A015 565
产品材质 纯铜
表面处理 亚黑



产品型号 EL022-A015 566
产品材质 纯铜
表面处理 卡其灰



产品型号 EL022-A015 561
产品材质 纯铜
表面处理 摩卡棕

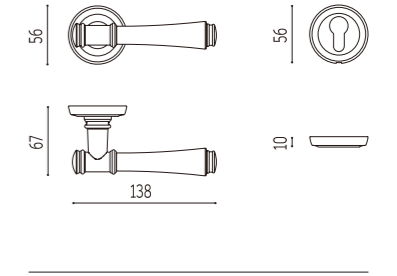

产品型号 A805-E003 565
 产品材质 纯铜
 表面处理 亚黑



产品型号 A805-E003 563
 产品材质 纯铜
 表面处理 黑古金



产品型号 A805-E003 561
 产品材质 纯铜
 表面处理 摩卡棕



产品型号 A805-E003 305
 产品材质 纯铜
 表面处理 咖啡古铜



产品型号 A805-E003 533
 产品材质 纯铜
 表面处理 法国黄古铜

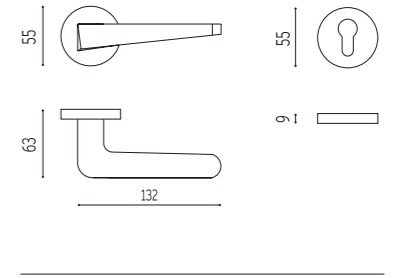

产品型号 A802-E004 565
产品材质 纯铜
表面处理 亚黑



产品型号 A802-E004 566
产品材质 纯铜
表面处理 卡其灰



产品型号 A802-E004 561
产品材质 纯铜
表面处理 摩卡棕



产品型号 A802-E004 533
产品材质 纯铜
表面处理 法国黄古铜



产品型号 A802-E004 901
产品材质 纯铜
表面处理 沙丁铜



安装新的门把手是一个很好的方式，去感受全新的生活体验。我们美拓的手柄不仅容易贴合各种装修风格，它本身也是惊人的艺术品。

Fitting new interior door handles is a great way of breathing new life into existing doors without going to the trouble and expense of replacing the entire door. Our Amertop handle is not only easy to fit, it looks simply stunning too.



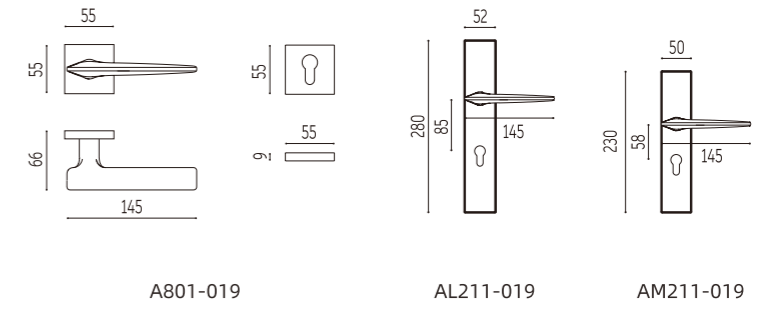

产品型号 A801-019 565
产品材质 纯铜
表面处理 亚黑



产品型号 A801-019 563
产品材质 纯铜
表面处理 黑古金



产品型号 A801-019 561
产品材质 纯铜
表面处理 摩卡棕



产品型号 A801-019 533
产品材质 纯铜
表面处理 法国黄古铜



产品型号 A801-019 901
产品材质 纯铜
表面处理 沙丁铜



产品型号 A801-019 536
产品材质 纯铜
表面处理 锆金



产品型号 AL211-019 565
产品材质 纯铜
表面处理 亚黑



产品型号 AL211-019 561
产品材质 纯铜
表面处理 摩卡棕



产品型号 AL211-019 533
产品材质 纯铜
表面处理 法国黄古铜

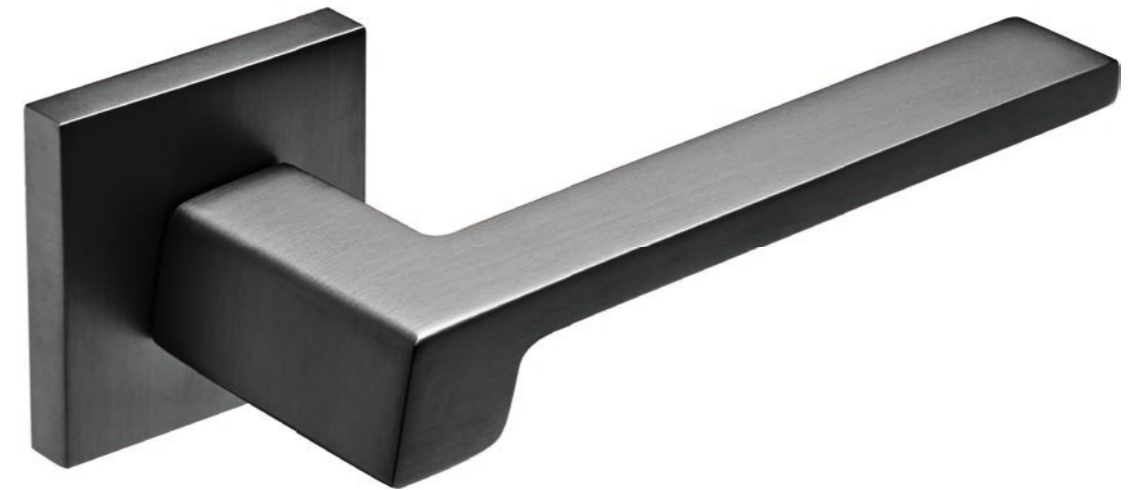
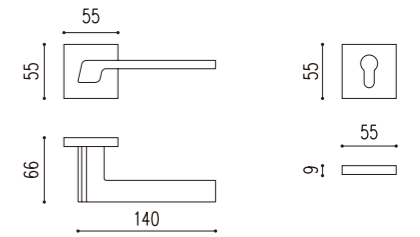
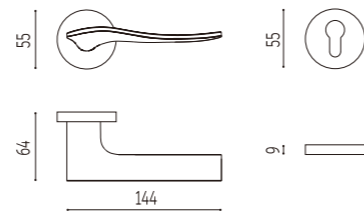

产品型号 A802-E005 563
产品材质 纯铜
表面处理 黑古金



产品型号 A801-E006 566
产品材质 纯铜
表面处理 卡其灰



产品型号 A802-E005 561
产品材质 纯铜
表面处理 摩卡棕



产品型号 A802-E005 533
产品材质 纯铜
表面处理 法国黄古铜



产品型号 A801-E006 305
产品材质 纯铜
表面处理 咖啡古铜



产品型号 A801-E006 901
产品材质 纯铜
表面处理 沙丁铜

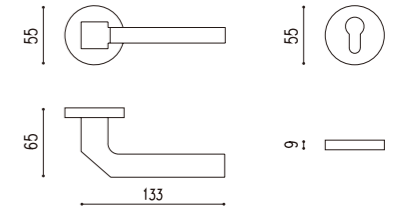
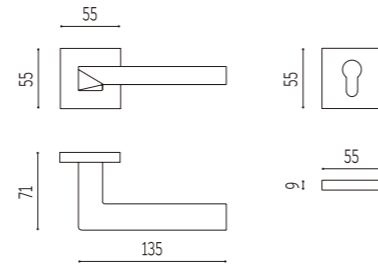

产品型号 A801-E007 901
产品材质 纯铜
表面处理 沙丁铜



产品型号 A802-E009 533
产品材质 纯铜
表面处理 法国黄古铜



产品型号 A801-E007 565
产品材质 纯铜
表面处理 亚黑



产品型号 A801-E007 566
产品材质 纯铜
表面处理 卡其灰



产品型号 A802-E009 565
产品材质 纯铜
表面处理 亚黑



产品型号 A802-E009 305
产品材质 纯铜
表面处理 咖啡古铜

FREE MIND

在高歌猛进时代更迭下，执笔设计、唤醒本真。带着对自然的真挚期许，让您在生活中有情调，灵魂有诗意、心神自由。

In the context of rapid era change,
Write design, awaken the truth.
With sincere expectations of nature
Let you have a passion in life,
The soul is poetic, the mind is free.



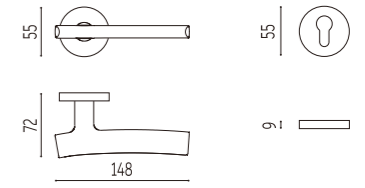

产品型号 A802-020 561
 产品材质 纯铜
 表面处理 摩卡棕



产品型号 A802-020 533
 产品材质 纯铜
 表面处理 法国黄古铜



产品型号 A802-020 536
 产品材质 纯铜
 表面处理 鍍金



产品型号 A802-020 202
 产品材质 纯铜
 表面处理 PVD 镍

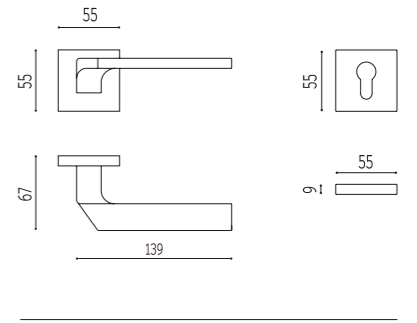

产品型号 A801-E008 565
产品材质 纯铜
表面处理 亚黑



产品型号 A801-E008 566
产品材质 纯铜
表面处理 卡其灰



产品型号 A801-E008 561
产品材质 纯铜
表面处理 摩卡棕



产品型号 A801-E008 533
产品材质 纯铜
表面处理 法国黄古铜



产品型号 A801-E008 901
产品材质 纯铜
表面处理 沙丁铜

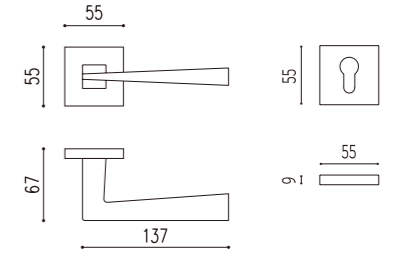

产品型号 A801-E010 565
 产品材质 纯铜
 表面处理 亚黑



产品型号 A801-E010 563
 产品材质 纯铜
 表面处理 黑古金



产品型号 A801-E010 901
 产品材质 纯铜
 表面处理 沙丁铜



ESSENTIAL NEUTRAL AESTHETICS

手柄具有必不可少的中性美学，像一把万能钥匙打开触感记忆，但它同时是当代的，也是现代的。

The handle has an essential neutral aesthetics and works like a sort of 'passe-partout' with a touch of memory, but it is contemporary and modern at the same time.



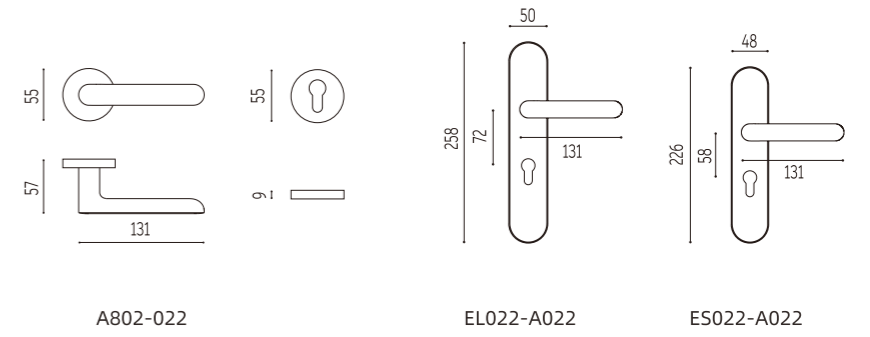

产品型号 A802-022 566
产品材质 纯铜
表面处理 卡其灰



产品型号 A802-022 533
产品材质 纯铜
表面处理 法国黄古铜



产品型号 A802-022 901
产品材质 纯铜
表面处理 沙丁铜



产品型号 A802-022 202
产品材质 纯铜
表面处理 PVD 镍



产品型号 EL022-A022 566
产品材质 纯铜
表面处理 卡其灰



产品型号 EL022-A022 533
产品材质 纯铜
表面处理 法国黄古铜



产品型号 EL022-A022 901
产品材质 纯铜
表面处理 沙丁铜

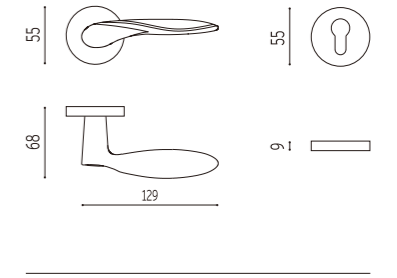

产品型号 A802-E023 565
 产品材质 纯铜
 表面处理 亚黑



产品型号 A802-E023 566
 产品材质 纯铜
 表面处理 卡其灰



产品型号 A802-E023 305
 产品材质 纯铜
 表面处理 咖啡古铜



产品型号 A802-E023 533
 产品材质 纯铜
 表面处理 法国黄古铜

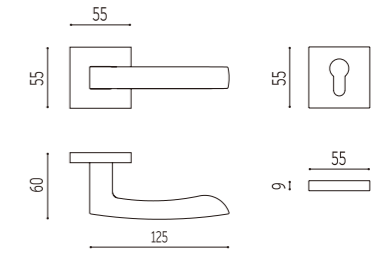
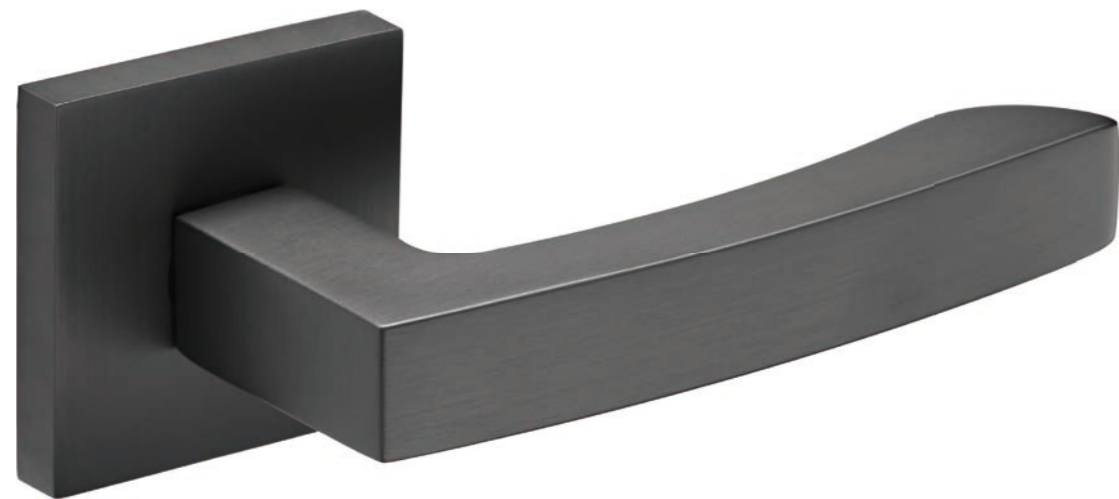

产品型号 A801-E024 565
产品材质 纯铜
表面处理 亚黑



产品型号 A801-E024 566
产品材质 纯铜
表面处理 卡其灰



产品型号 A801-E024 561
产品材质 纯铜
表面处理 摩卡棕



产品型号 A801-E024 533
产品材质 纯铜
表面处理 法国黄古铜



产品型号 A801-E024 901
产品材质 纯铜
表面处理 沙丁铜

INSPIRED BY NATURE

融合自然之灵感，以艺术美学解读。将铜材独一无二的美，巧妙的运用到执手设计中。大自然蕴藏的无限能量，凝神韵、铸灵性，赋予每一款执手个性。造化出独一无二的质感，是时间长河里留下的珍异无双的美丽印记。

Inspired by nature, interpreted with artistic aesthetics. The unique beauty of copper cleverly used in the handle design. The infinite energy contained in nature, concentrate on charm, cast spirituality. Give each handle a personality. Create a unique texture. It is left in the river of time, rare unparalleled beauty mark.



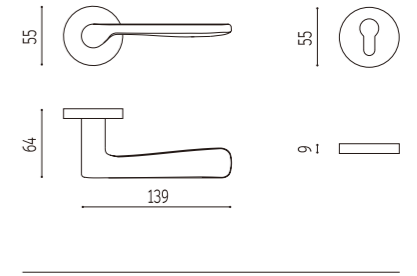

产品型号 A802-023 565
 产品材质 纯铜
 表面处理 亚黑



产品型号 A802-023 566
 产品材质 纯铜
 表面处理 卡其灰



产品型号 A802-023 533
 产品材质 纯铜
 表面处理 法国黄古铜



产品型号 A802-023 901
 产品材质 纯铜
 表面处理 沙丁铜



产品型号 A802-023 520
 产品材质 纯铜
 表面处理 玫瑰金



产品型号 A802-023 202
 产品材质 纯铜
 表面处理 PVD 镍

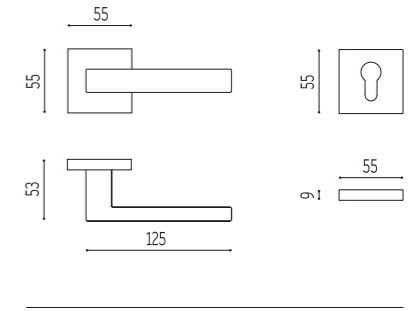

产品型号 A801-E025 565
产品材质 纯铜
表面处理 亚黑



产品型号 A801-E025 566
产品材质 纯铜
表面处理 卡其灰



产品型号 A801-E025 533
产品材质 纯铜
表面处理 法国黄古铜

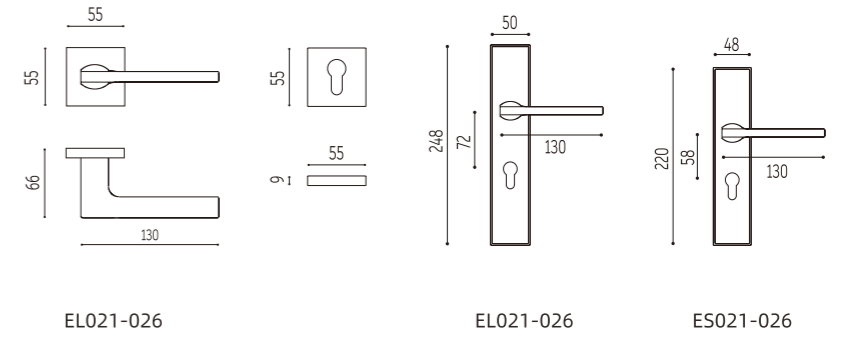

EL021-026

EL021-026

ES021-026



产品型号 A801-E026 565
 产品材质 纯铜
 表面处理 亚黑



产品型号 A801-E026 566
 产品材质 纯铜
 表面处理 卡其灰



产品型号 A801-E026 561
 产品材质 纯铜
 表面处理 摩卡棕



产品型号 A801-E026 305
 产品材质 纯铜
 表面处理 咖啡古铜



产品型号 A801-E026 533
 产品材质 纯铜
 表面处理 法国黄古铜



产品型号 A801-E026 103
 产品材质 纯铜
 表面处理 镀铬



产品型号 EL021-026 565
 产品材质 纯铜
 表面处理 亚黑



产品型号 EL021-026 566
 产品材质 纯铜
 表面处理 卡其灰



产品型号 EL021-026 561
 产品材质 纯铜
 表面处理 摩卡棕



WHILE DETERMINED TO INNOVATE

AMERTOP 秉持以自然为灵感,用奇幻曼妙的设计与精湛的制造工艺,将大自然的美好融入家居的灵魂深处,运用现代都市风格重新渲染,谱写自然与城市的和谐乐章。

AMERTOP upholds nature as inspiration,With fantastic design and exquisite manufacturing technology.Incorporate the beauty of nature into the soul of the home,Re-render the use of modern urban style.Compose a harmonious movement between nature and the city.

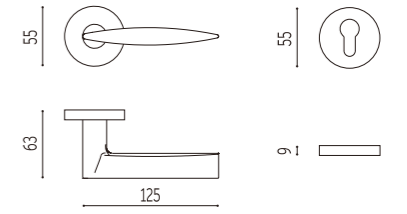

产品型号 **A802-E021 566**
 产品材质 纯铜
 表面处理 卡其灰



产品型号 **A802-E021 103**
 产品材质 纯铜
 表面处理 镀铬



产品型号 **A802-E021 536**
 产品材质 纯铜
 表面处理 镀金

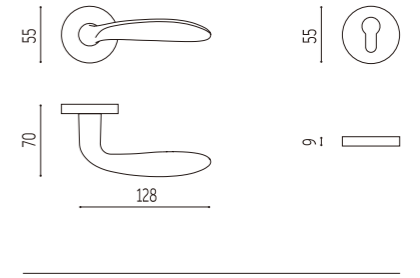

产品型号 A802-LQ01 565
 产品材质 纯铜
 表面处理 亚黑



产品型号 A802-LQ01 566
 产品材质 纯铜
 表面处理 卡其灰



产品型号 A802-LQ01 901
 产品材质 纯铜
 表面处理 沙丁铜

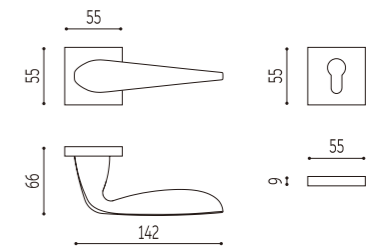

产品型号 A801-E022 565
产品材质 纯铜
表面处理 亚黑



产品型号 A801-E022 566
产品材质 纯铜
表面处理 卡其灰



产品型号 A801-E022 561
产品材质 纯铜
表面处理 摩卡棕



产品型号 A801-E022 533
产品材质 纯铜
表面处理 法国黄古铜



产品型号 A801-E022 901
产品材质 纯铜
表面处理 沙丁铜



产品型号 A801-E022 103
产品材质 纯铜
表面处理 镀铬



THE ENERGY OF NATURE IS POWERFUL AND INFINITE

以艺术的眼光
看待铜制品的千万姿态
以创新的精神
探索自然的包罗万象
则赋予了执手
全新的生命意义

Look at the tens of millions of
copper products, from an artistic
perspective. With an innovative
spirit.
Explore the all-encompassing
nature of nature.
Handle, a new meaning of life.

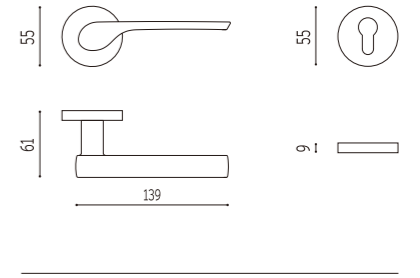

产品型号 A802-E027 566
产品材质 纯铜
表面处理 卡其灰



产品型号 A802-E027 561
产品材质 纯铜
表面处理 摩卡棕



产品型号 A802-E027 536
产品材质 纯铜
表面处理 镀金

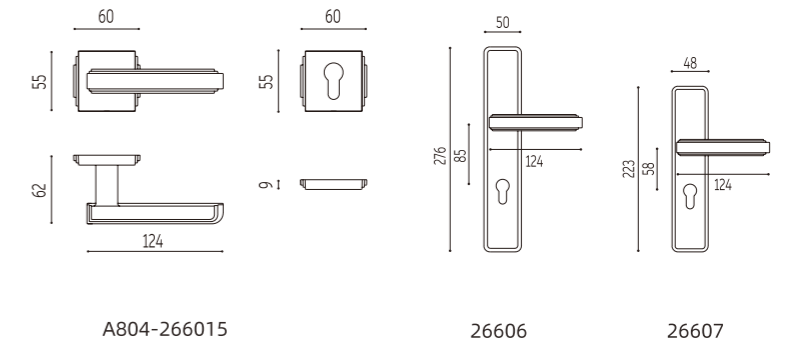

产品型号 A804-266015 561
产品材质 纯铜
表面处理 摩卡棕



产品型号 A804-266015 305
产品材质 纯铜
表面处理 咖啡古铜



产品型号 A804-266015 533
产品材质 纯铜
表面处理 法国黄古铜



产品型号 A804-266015 901
产品材质 纯铜
表面处理 沙丁铜



产品型号 A804-266015 202
产品材质 纯铜
表面处理 PVD 镍



产品型号 26606 561
产品材质 纯铜
表面处理 摩卡棕



产品型号 26606 305
产品材质 纯铜
表面处理 咖啡古铜



产品型号 26606 533
产品材质 纯铜
表面处理 法国黄古铜

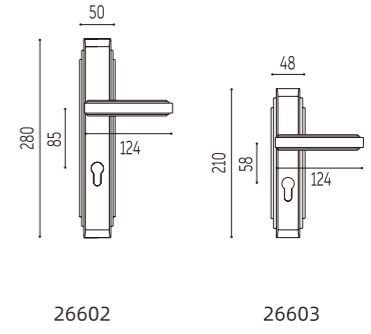

产品型号 26602 561
 产品材质 纯铜
 表面处理 摩卡棕



产品型号 26602 305
 产品材质 纯铜
 表面处理 咖啡古铜



产品型号 26602 533
 产品材质 纯铜
 表面处理 法国黄古铜



产品型号 26602 901
 产品材质 纯铜
 表面处理 沙丁铜



产品型号 26602 202
 产品材质 纯铜
 表面处理 PVD 镍

FREE MIND

在高歌猛进时代更迭下,执笔设计、
唤醒本真,带着对自然的真挚期许,
让您在生活中有情调,灵魂有诗意、
心神自由。

In the context of rapid era change.
Creative design, awaken the truth
With sincere expectations of
natureLet you have a passion in
life.The soul is poetic, the mind is
free.

104



MODERN

现代
颠覆古典
打破均衡
让金线如此熠熠生辉



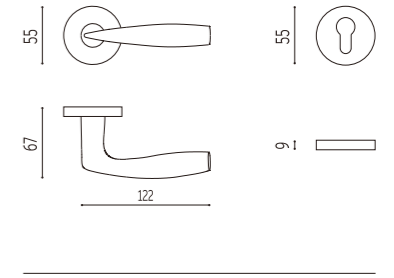

产品型号 A802-E028 566
 产品材质 纯铜
 表面处理 卡其灰



产品型号 A802-E028 561
 产品材质 纯铜
 表面处理 摩卡棕



产品型号 A802-E028 533
 产品材质 纯铜
 表面处理 法国黄古铜

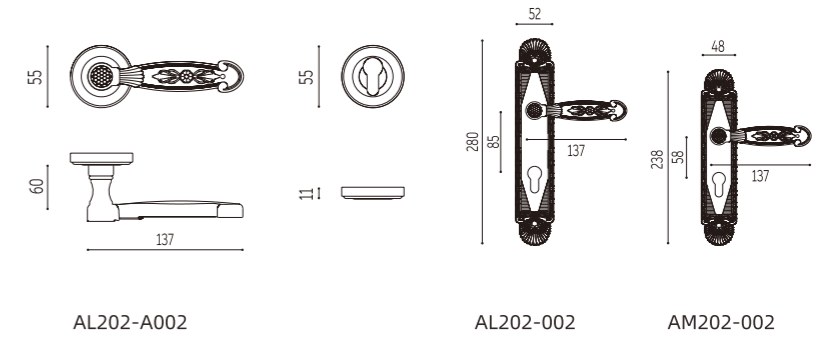

AL202-A002

AL202-002

AM202-002



产品型号 A803-002 305
 产品材质 纯铜
 表面处理 咖啡古铜



产品型号 A803-002 533
 产品材质 纯铜
 表面处理 法国黄古铜



产品型号 A803-002 564
 产品材质 纯铜
 表面处理 古典金



产品型号 AL202-002 305
 产品材质 纯铜
 表面处理 咖啡古铜



产品型号 AL202-002 533
 产品材质 纯铜
 表面处理 法国黄古铜



产品型号 AL202-002 564
 产品材质 纯铜
 表面处理 古典金

PRECIOUS

华贵
尽情地演奏如诗的旋律
它高贵优雅
一室的艺术气息弥漫着



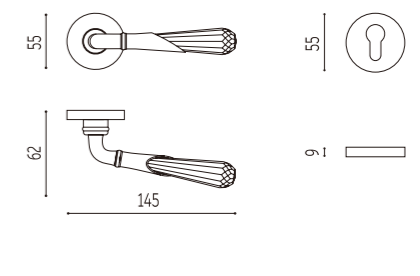

产品型号 A802-1621 520
产品材质 纯铜 + 白色水晶
表面处理 玫瑰金



产品型号 A802-1621 536
产品材质 纯铜 + 白色水晶
表面处理 鎏金



产品型号 A802-1621 103
产品材质 纯铜 + 白色水晶
表面处理 镀铬



产品型号 A802-1621 103
产品材质 纯铜 + 紫色水晶
表面处理 镀铬



本款适配 A803 圆盘

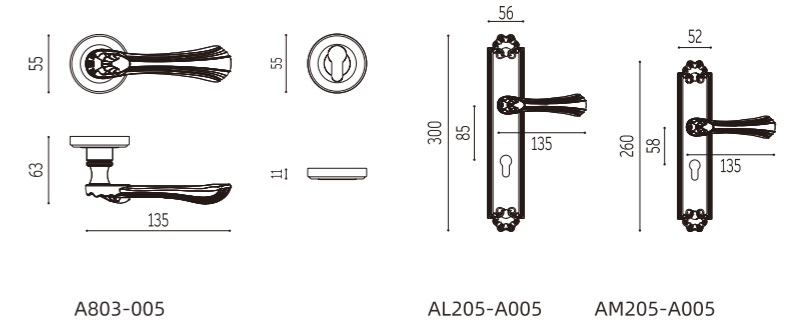

产品型号 A803-005 305
产品材质 纯铜
表面处理 咖啡古铜



产品型号 A803-005 533
产品材质 纯铜
表面处理 法国黄古铜



产品型号 A803-005 564
产品材质 纯铜
表面处理 古典金



产品型号 A803-005 211
产品材质 纯铜
表面处理 真金



产品型号 AL205-005 305
产品材质 纯铜
表面处理 咖啡古铜



产品型号 AL205-005 533
产品材质 纯铜
表面处理 法国黄古铜



产品型号 AL205-005 564
产品材质 纯铜
表面处理 古典金

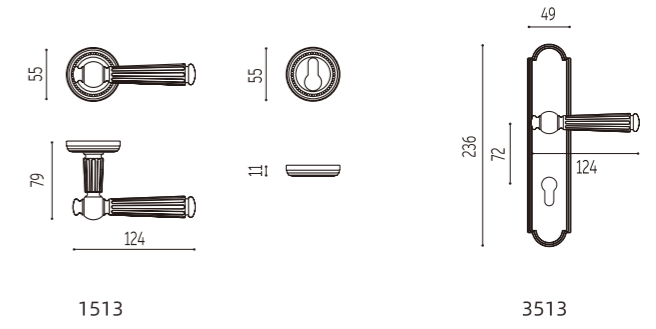

产品型号 1513 536
 产品材质 纯铜
 表面处理 鍍金

产品型号 1513 103
 产品材质 纯铜
 表面处理 鍍鉻



产品型号 3513 536
 产品材质 纯铜
 表面处理 鍍金

产品型号 3513 103
 产品材质 纯铜
 表面处理 鍍鉻

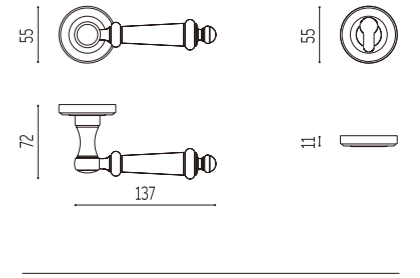

产品型号 A803-016 561
产品材质 纯铜
表面处理 摩卡棕



产品型号 A803-016 533
产品材质 纯铜
表面处理 法国黄古铜



产品型号 A803-016 536
产品材质 纯铜
表面处理 镀金



产品型号 A803-016 202
产品材质 纯铜
表面处理 PVD 镍



产品型号 AL210-016 533
产品材质 纯铜
表面处理 法国黄古铜



产品型号 AL210-016 536
产品材质 纯铜
表面处理 镀金

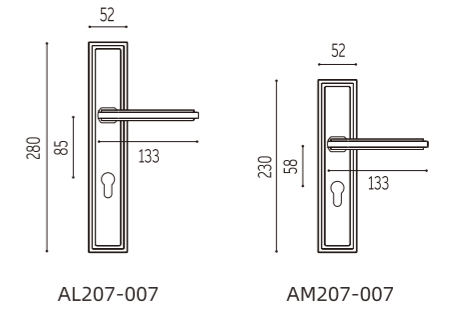

产品型号 AL207-007 307
 产品材质 纯铜
 表面处理 沙丁古铜

产品型号 AM207-007 307
 产品材质 纯铜
 表面处理 沙丁古铜

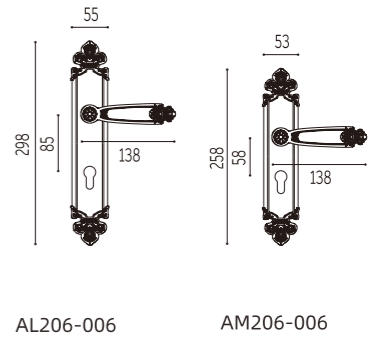

AL206-006 AM206-006



产品型号 AL206-006 305
产品材质 纯铜
表面处理 咖啡古铜



产品型号 AL206-006 533
产品材质 纯铜
表面处理 法国黄古铜



产品型号 AL206-006 564
产品材质 纯铜
表面处理 古典金



产品型号 AL206-006 211
产品材质 纯铜
表面处理 真金



产品型号 AL206-006 538
产品材质 纯铜
表面处理 欧洲古银

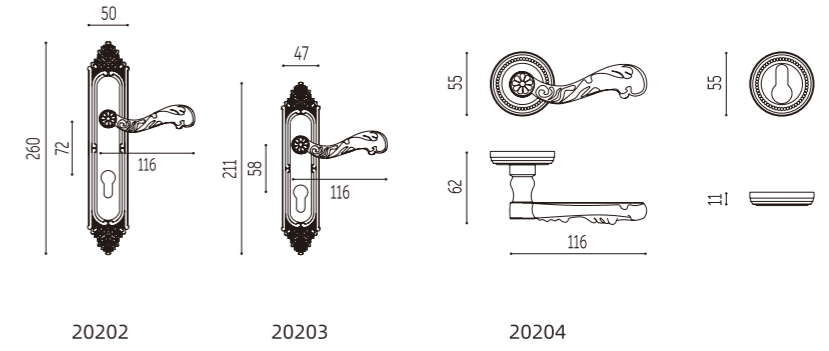

产品型号 20202 305
产品材质 纯铜
表面处理 咖啡古铜



产品型号 20202 403
产品材质 纯铜
表面处理 欧洲金



产品型号 20202 211
产品材质 纯铜
表面处理 真金



产品型号 20204 305
产品材质 纯铜
表面处理 咖啡古铜



产品型号 20204 403
产品材质 纯铜
表面处理 欧洲金



产品型号 20204 211
产品材质 纯铜
表面处理 真金

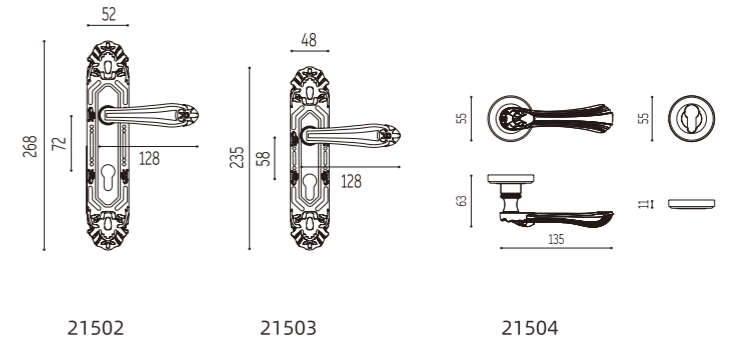

产品型号 21502 305
产品材质 纯铜
表面处理 咖啡古铜



产品型号 21502 403
产品材质 纯铜
表面处理 欧洲金



产品型号 21502 211
产品材质 纯铜
表面处理 真金



产品型号 21504 305
产品材质 纯铜
表面处理 咖啡古铜



产品型号 21504 403
产品材质 纯铜
表面处理 欧洲金



产品型号 21504 211
产品材质 纯铜
表面处理 真金

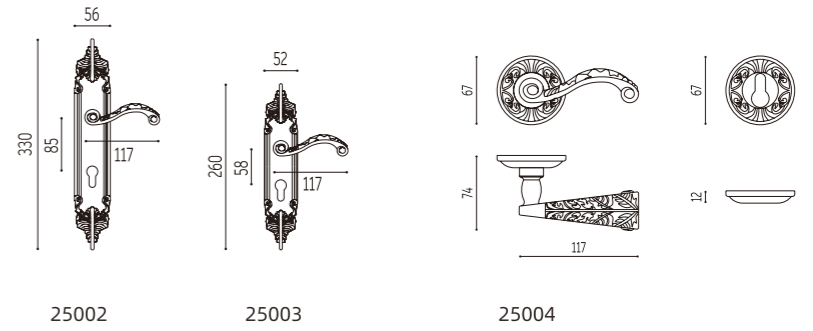

产品型号 25002 305
产品材质 纯铜
表面处理 咖啡古铜



产品型号 25002 407
产品材质 纯铜
表面处理 欧洲金亚漆



产品型号 25002 211
产品材质 纯铜
表面处理 真金



产品型号 25004 305
产品材质 纯铜
表面处理 咖啡古铜



产品型号 25004 407
产品材质 纯铜
表面处理 欧洲金亚漆



产品型号 25004 211
产品材质 纯铜
表面处理 真金

HANDLE 拉手



A901-M
纯铜



A901-S
纯铜



表面处理

- 202 - PVD 镍
- 533 - 法国黄古铜
- 305 - 咖啡色
- 565 - 亚黑
- 566 - 卡其灰
- 536 - 鍍金
- 520 - 玫瑰金
- 901 - 沙丁铜



A902
纯铜



A902-96
纯铜

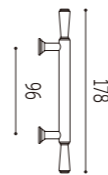

A902-128
纯铜

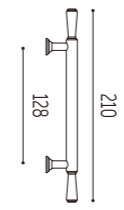

A902-152
纯铜

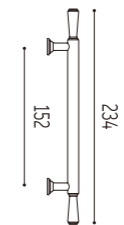

A902B
纯铜



A902B-96
纯铜

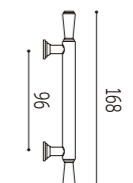

A902B-128
纯铜

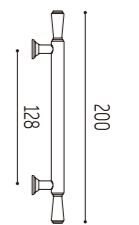

A902B-152
纯铜

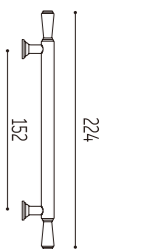

表面处理

- 901 - 沙丁铜
- 533 - 法国黄古铜
- 536 - 鍍金
- 520 - 玫瑰金
- 202 - PVD 镍
- 565 - 亚黑

表面处理

- 103 - 亮铬
- 536 - 锆金
- 520 - 玫瑰金
- 305 - 咖啡色
- 533 - 法国黄古铜

A903-96

纯铜

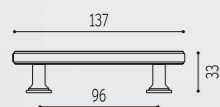

A903-128

纯铜



A903-152

纯铜

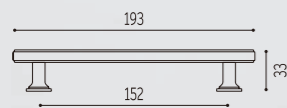

表面处理

- 202 - PVD 镍
- 536 - 锆金
- 520 - 玫瑰金
- 104 - 铜拉丝
- 565 - 亚黑
- 566 - 卡其灰
- 305 - 咖啡色
- 533 - 法国黄古铜

A904-M

纯铜



A904-S

纯铜





A906-96
纯铜

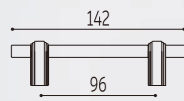

A906-128
纯铜

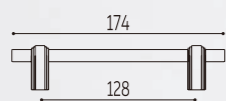

A906-152
纯铜

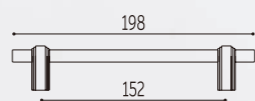

表面处理

- 202 - 亮铬
- 536 - 锆金
- 520 - 玫瑰金
- 565 - 亚黑
- 566 - 卡其灰
- 305 - 咖啡色
- 533 - 法国黄古铜



表面处理

- 305 - 咖啡色
- 533 - 法国黄古铜
- 520 - 玫瑰金
- 536 - 锆金
- 202 - PVD 镍
- 103 - 亮铬



A908-96
纯铜

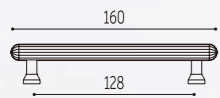

A908-128
纯铜

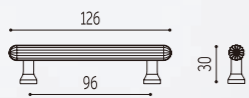

A908-5
纯铜



表面处理

- 536 - 鍍金
- 565 - 亞黑
- 566 - 卡其灰
- 533 - 法國黃古銅
- 305 - 咖啡色
- 901 - 沙丁銅



表面处理

- 403 - 歐洲金
- 305 - 咖啡古銅
- 901 - 沙丁銅

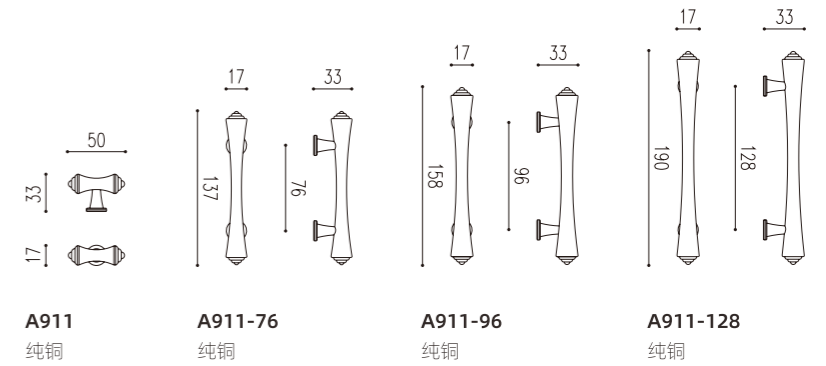



表面处理

- 536- 锆金
- 202-PVD 镍
- 565- 亚黑
- 566- 卡其灰

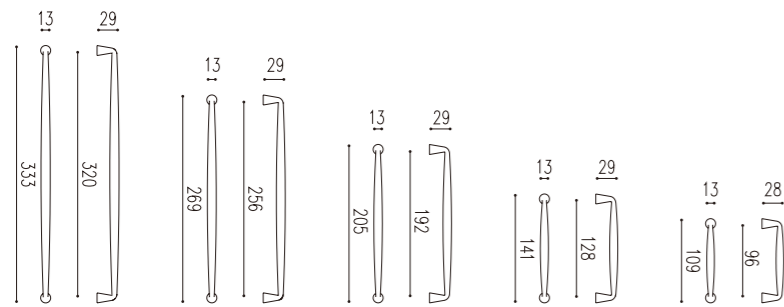

A916-320 纯铜
A916-256 纯铜
A916-192 纯铜
A916-128 纯铜
A916-96 纯铜



表面处理

- 305 - 咖啡古铜
- 533 - 法国黄古铜
- 560 - 亚丝金

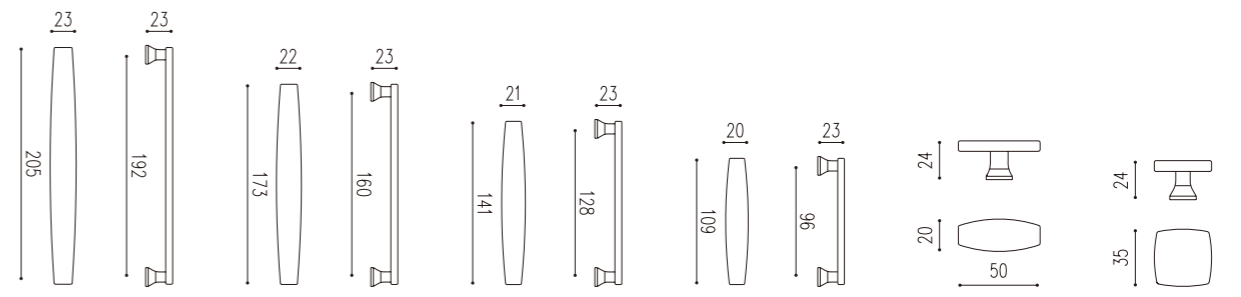

A919-192 纯铜
A919-160 纯铜
A919-128 纯铜
A919-96 纯铜
A919-50 纯铜
A919-35 纯铜

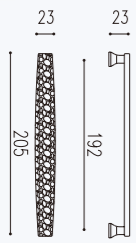

A918-192
纯铜

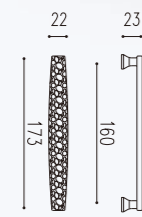

A918-160
纯铜

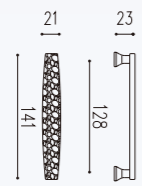

A918-128
纯铜

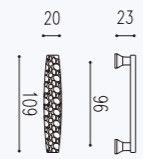

A918-96
纯铜

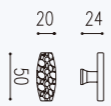

A918-50
纯铜



A918-35
纯铜

表面处理

533- 法国黄古铜
305- 咖啡古铜



A920-96
纯铜

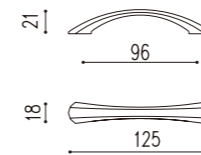

A920-128
纯铜

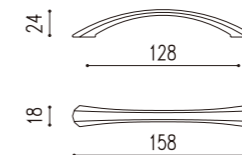

表面处理

566- 卡其灰
533- 法国黄古铜



表面处理

- 560- 亚丝金
- 566- 卡其灰

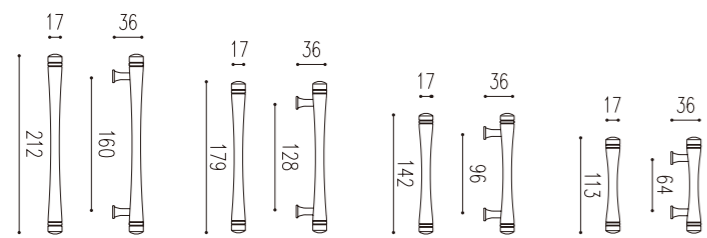

A921-160 纯铜
A921-128 纯铜
A921-96 纯铜
A921-64 纯铜



A925-30 纯铜
A925-34 纯铜

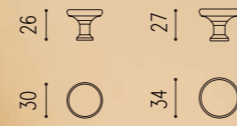

表面处理

- 305- 咖啡古铜
- 565- 亚黑
- 566- 卡其灰
- 560- 亚丝金

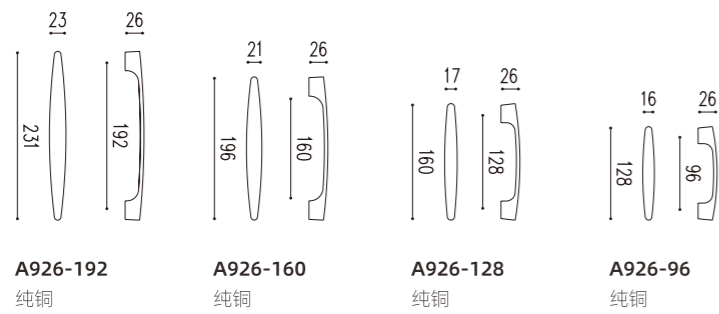

表面处理

- 305- 咖啡古铜
- 566- 卡其灰
- 560- 亚丝金



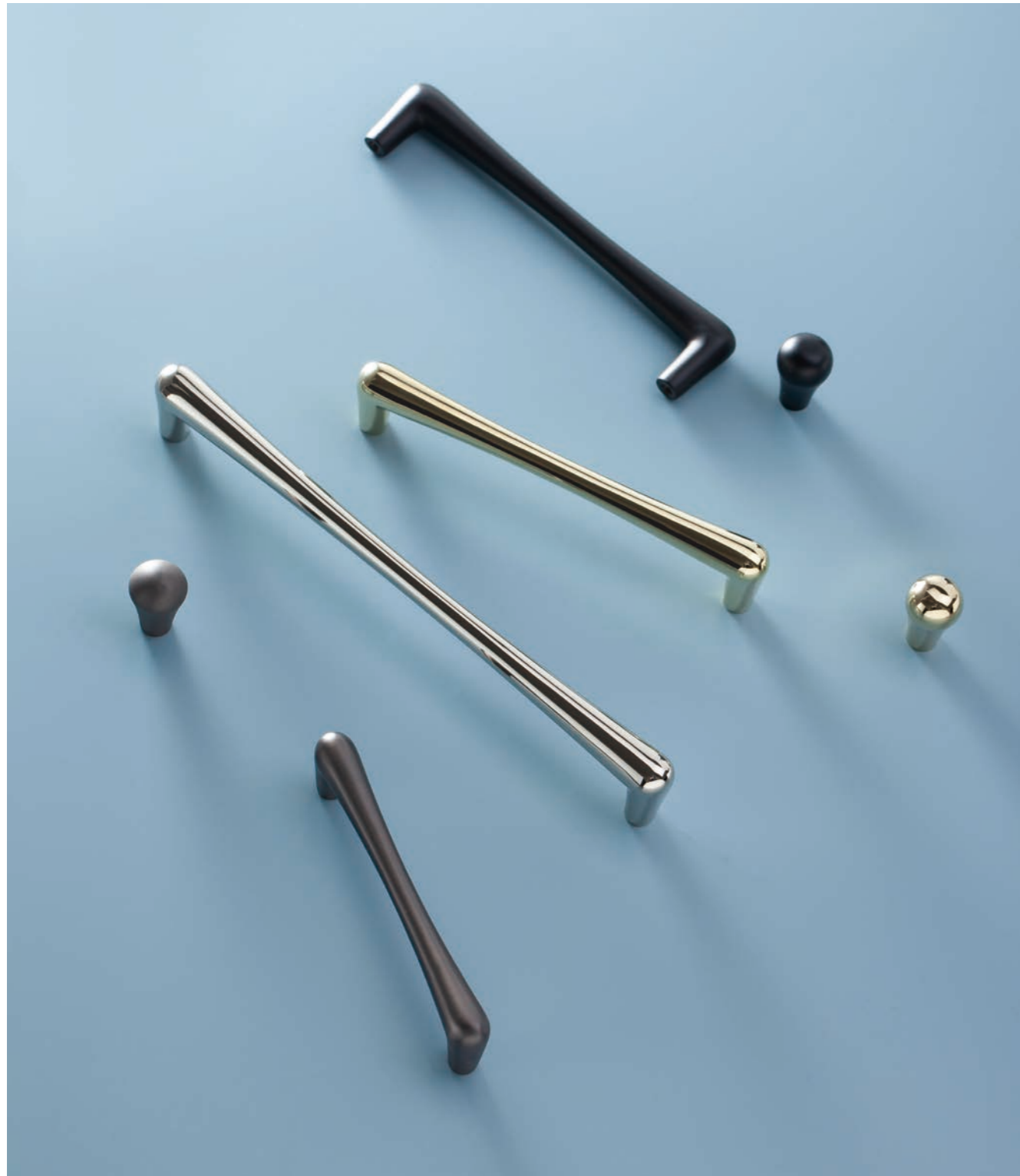

A927-192 纯铜	A927-128 纯铜	A927-96 纯铜	A927-18 纯铜

表面处理

- 565- 亚黑
- 566- 卡其灰
- 202- PVD 镍
- 536- 镀金



A930-96 纯铜	A930-128 纯铜	A930-160 纯铜	A930-192 纯铜

表面处理

- 536- 镀金

A937-192
纯铜

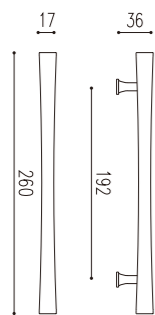

A937-160
纯铜

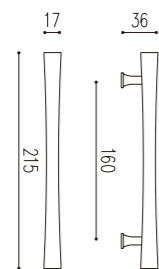

A937-128
纯铜

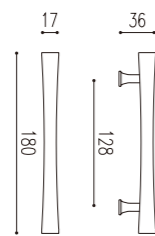

A937-96
纯铜

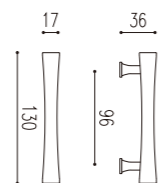

表面处理

305 - 咖啡古铜
560 - 亚丝金

表面处理

533- 法国黄古铜
305- 咖啡古铜



A960-32
纯铜

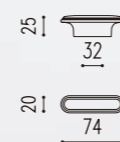

A960-64
纯铜

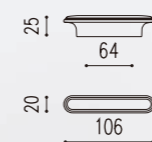

A960-96
纯铜

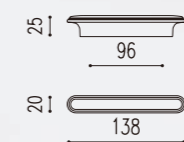

A960-128
纯铜

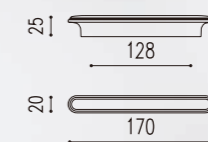



A986-32
纯铜

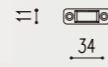
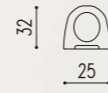

表面处理

- 565- 亚黑
- 103- 镀铬
- 901- 沙丁铜



A967-128
纯铜

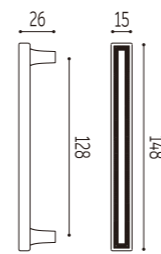

A967-96
纯铜

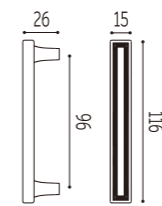

A967-5
纯铜



表面处理

- 565 - 亚黑
- 564 - 古典金
- 533 - 法国黄古铜
- 211 - 真金
- 305 - 咖啡色

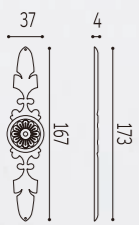

80303
纯铜

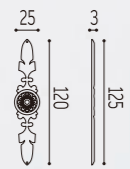

80304
纯铜



80301
纯铜



80302
纯铜

表面处理

305 - 咖啡色
403 - 欧洲金

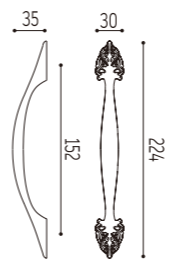

81801
纯铜

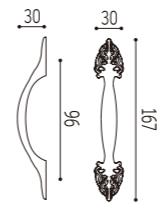

81802
纯铜



81804
纯铜

表面处理

305 - 咖啡色
407 - 欧洲金亚漆

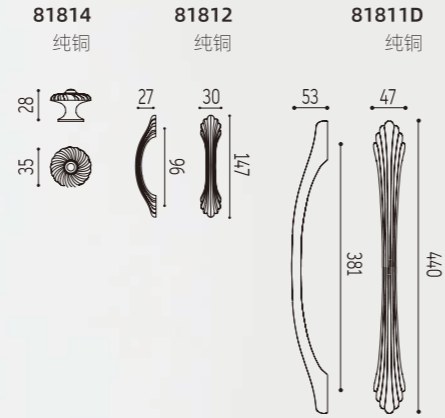

表面处理

305- 咖啡色
407- 欧洲金亚漆



表面处理

305- 咖啡色
407- 欧洲金亚漆

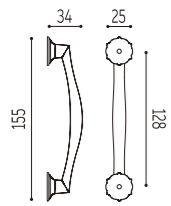

82300
纯铜

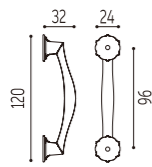

82301
纯铜

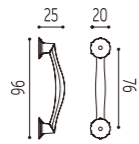

82302
纯铜



82303
纯铜

表面处理

- 305 - 咖啡色
- 566 - 卡其灰
- 561 - 摩卡棕
- 304 - 亮油古铜



82502
纯铜

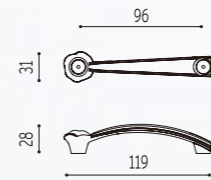

82503
纯铜

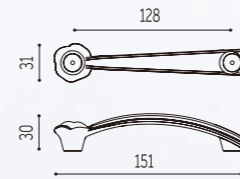

82500
纯铜

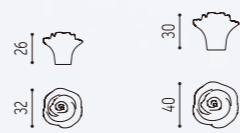

82501
纯铜



表面处理

- 305 - 咖啡色
- 407 - 欧洲金亚漆
- 403 - 欧洲金

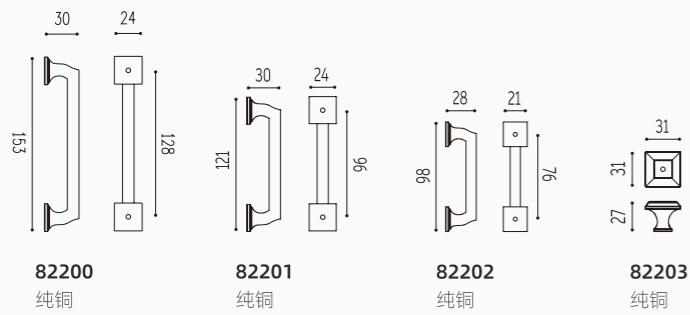

表面处理

- 305- 咖啡色
- 566- 卡其灰
- 565- 亚黑
- 304- 亮油古铜
- 533- 法国黄古铜



产品型号 A915-S 565
 产品材质 纯铜
 表面处理 亚黑



产品型号 A915-S 305
 产品材质 纯铜
 表面处理 咖啡古铜



产品型号 A915-S 901
 产品材质 纯铜
 表面处理 沙丁铜



产品型号 81514 304
 产品材质 纯铜
 表面处理 亮油古铜



产品型号 81514 101
 产品材质 纯铜
 表面处理 亮铜



产品型号 81513 304
 产品材质 纯铜
 表面处理 亮油古铜



产品型号 81503 101
 产品材质 纯铜
 表面处理 亮铜

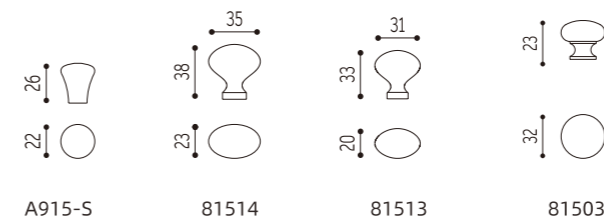

ACCESSORIES 配件



产品型号 70211A 565
产品材质 纯铜
表面处理 亚黑



产品型号 70211A 305
产品材质 纯铜
表面处理 咖啡古铜



产品型号 70211A 533
产品材质 纯铜
表面处理 法国莫古铜



产品型号 70212 565
产品材质 纯铜
表面处理 亚黑



产品型号 70212 305
产品材质 纯铜
表面处理 咖啡古铜



产品型号 70212 561
产品材质 纯铜
表面处理 摩卡棕



产品型号 70212A 565
产品材质 纯铜
表面处理 亚黑



产品型号 70212A 305
产品材质 纯铜
表面处理 咖啡古铜



产品型号 70212A 561
产品材质 纯铜
表面处理 摩卡棕

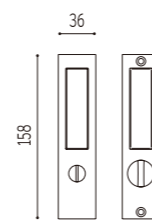

70211A

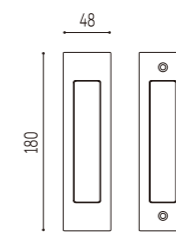

70212

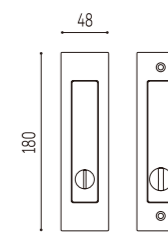

70212A



产品型号 70206 563
产品材质 纯铜
表面处理 黑古金



产品型号 70206 561
产品材质 纯铜
表面处理 摩卡棕



产品型号 70206 901
产品材质 纯铜
表面处理 沙丁棕



产品型号 70213 566
产品材质 纯铜
表面处理 卡其灰



产品型号 70213 561
产品材质 纯铜
表面处理 摩卡棕



产品型号 70213 533
产品材质 纯铜
表面处理 法国黄古铜



产品型号 70205B 565
产品材质 纯铜
表面处理 亚黑



产品型号 70205B 566
产品材质 纯铜
表面处理 卡其灰



产品型号 70205B 561
产品材质 纯铜
表面处理 摩卡棕



产品型号 70213A 305
产品材质 纯铜
表面处理 咖啡古铜



产品型号 70213A 533
产品材质 纯铜
表面处理 法国黄古铜



产品型号 70202 565
产品材质 纯铜
表面处理 亚黑



产品型号 70202 566
产品材质 纯铜
表面处理 卡其灰



产品型号 70202 561
产品材质 纯铜
表面处理 摩卡棕

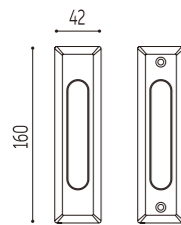

70206

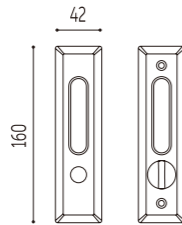

70205B

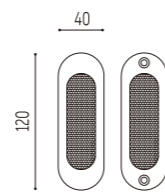

70202

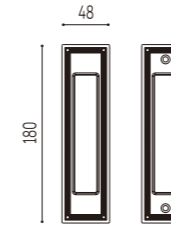

70213

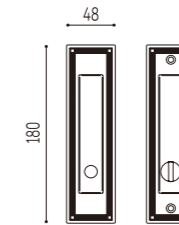

70213A



产品型号 70301 565
产品材质 纯铜
表面处理 亚黑



产品型号 70301 566
产品材质 纯铜
表面处理 卡其灰



产品型号 70301 901
产品材质 纯铜
表面处理 沙丁铜



产品型号 70302 565
产品材质 纯铜
表面处理 亚黑



产品型号 70302 566
产品材质 纯铜
表面处理 卡其灰



产品型号 70302 533
产品材质 纯铜
表面处理 法国黄古铜



产品型号 70315 565
产品材质 纯铜
表面处理 亚黑



产品型号 70315 533
产品材质 纯铜
表面处理 法国黄古铜



产品型号 70315 901
产品材质 纯铜
表面处理 沙丁铜

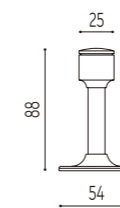

70301

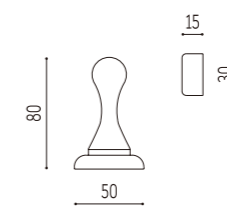

70302

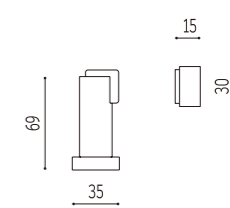

70315



产品型号 70304 565
产品材质 纯铜
表面处理 亚黑



产品型号 70304 566
产品材质 纯铜
表面处理 卡其灰



产品型号 70304 561
产品材质 纯铜
表面处理 摩卡棕



产品型号 70304 563
产品材质 纯铜
表面处理 黑古金



产品型号 70304 533
产品材质 纯铜
表面处理 法国黄古铜



产品型号 70304 901
产品材质 纯铜
表面处理 沙丁铜

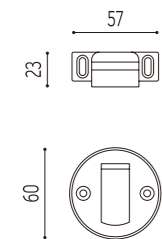

70304



产品型号 70303 305
产品材质 纯铜
表面处理 咖啡古铜



产品型号 70303 118
产品材质 纯铜
表面处理 欧洲铜



产品型号 70306 305
产品材质 纯铜
表面处理 咖啡古铜



产品型号 70306 403
产品材质 纯铜
表面处理 欧洲金



产品型号 70308 305
产品材质 纯铜
表面处理 咖啡古铜



产品型号 70308 403
产品材质 纯铜
表面处理 欧洲金



70303

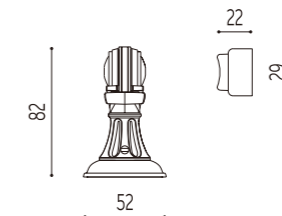

70306

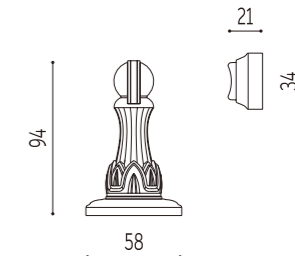

70308



DB105-12 565
纯铜
亚黑

D2 565

DB105-12 566
纯铜
卡其灰

D2 566

DB105-12 561
纯铜
摩卡棕

D2 561

DB105-12 533
纯铜
法国黄古铜

D2 533

DB105-12 901
纯铜
沙丁铜

D2 901



D3 565
纯铜
亚黑



D3 566
纯铜
卡其灰



D3 901
纯铜
沙丁铜

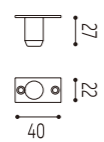

D2



D3

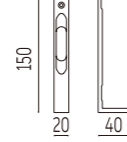

DB105-6

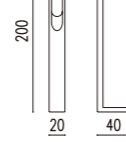

DB105-8

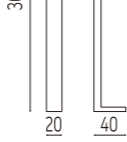

DB105-12

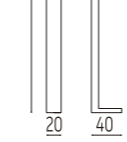

DB105-18

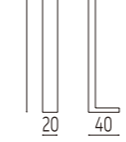

DB105-24

CLASSIC 经典系列



20302-565
亚黑



20303-565
亚黑



20304-565
亚黑



20706-307
沙丁古铜



20702-307
沙丁古铜



20703-307
沙丁古铜



20406-305
咖啡古铜



20405-305
咖啡古铜



20407-305
咖啡古铜



20704-307
沙丁古铜



20705-307
沙丁古铜



20717-307
沙丁古铜



20718-307
沙丁古铜



20402-305
咖啡古铜



20403-305
咖啡古铜



20408-305
咖啡古铜



20802-305
咖啡古铜



20803-305
咖啡古铜



20804-305
咖啡古铜



20803-403
欧洲金



20502-314
深古铜



20503-403
欧洲金



20504-314
深古铜



20503-305
咖啡古铜



20906-403
欧洲金



20902-305
咖啡古铜



20903-403
欧洲金



20904-403
欧洲金



20602-305
咖啡古铜



20602-211
真金



21002-305
咖啡古铜



21103-305
咖啡古铜



21005-305
咖啡古铜



20606-403
欧洲金



20603-403
欧洲金



20604-403
欧洲金



21102-403
欧洲金



21103-403
欧洲金



21104-403
欧洲金



21102-305
咖啡古铜



21207-403
欧洲金



21208-403
欧洲金



21306-403
欧洲金



21302-403
欧洲金



21304-403
欧洲金



21302-305
咖啡古铜



21303-305
咖啡古铜



21302-211
真金



21702-403
欧洲金



21704-403
欧洲金



20206-403
欧洲金



21902-304
亮油古铜

21903-304
亮油古铜



21904-304
亮油古铜

21905-304
亮油古铜



21904-305
咖啡古铜

◆：该图形代表“定制款”



21906-304
亮油古铜



21912-304
亮油古铜



21913-304
亮油古铜



21922-304
亮油古铜



22006-565
亚黑



22007-565
亚黑



22004-565
亚黑



22005-565
亚黑



22106-304
亮油古铜



22104-304
亮油古铜



22105-304
亮油古铜



22202-305
咖啡古铜



22203-305
咖啡古铜



22204-305
咖啡古铜



22205-305
咖啡古铜



22202-304
亮油古铜



22206-305
咖啡古铜



22306-303
油古铜



22304-303
油古铜



22307-303
油古铜



22305-303
油古铜

◆：该图形代表“定制款”

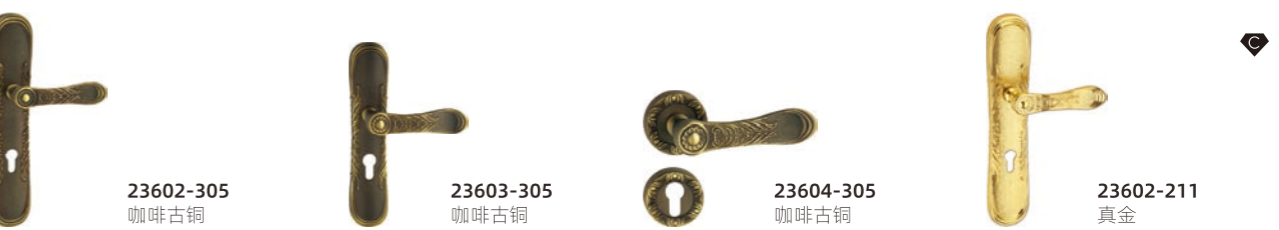
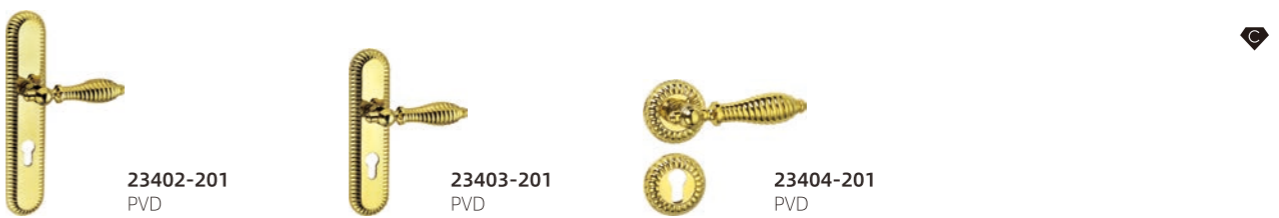
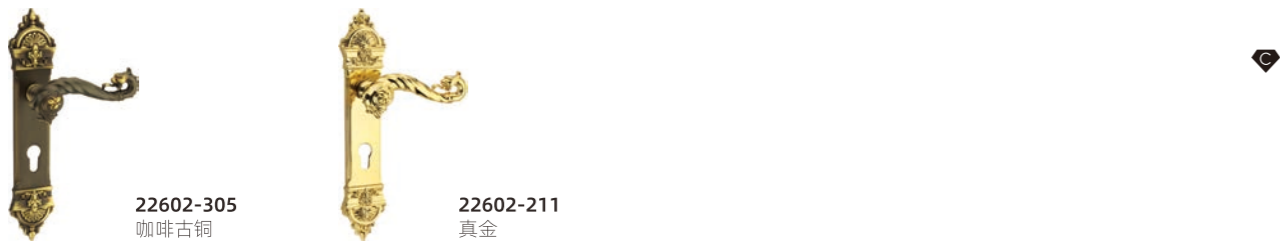
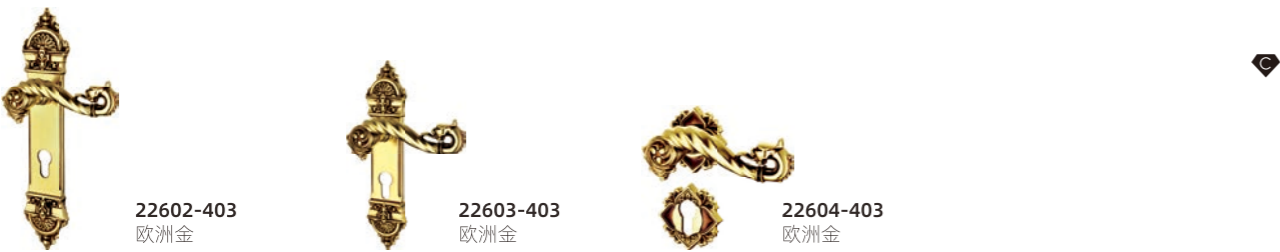
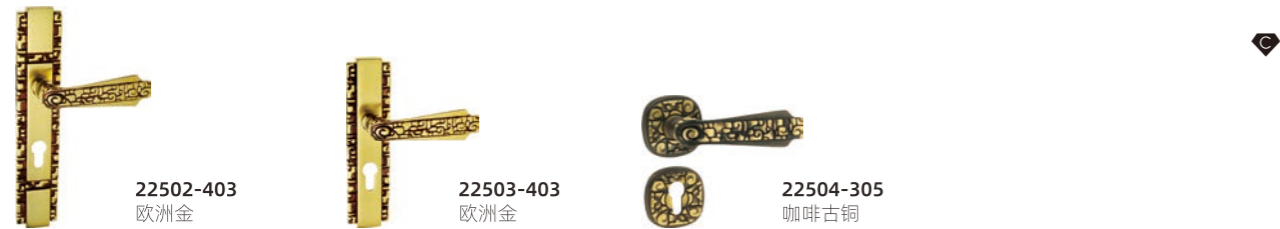

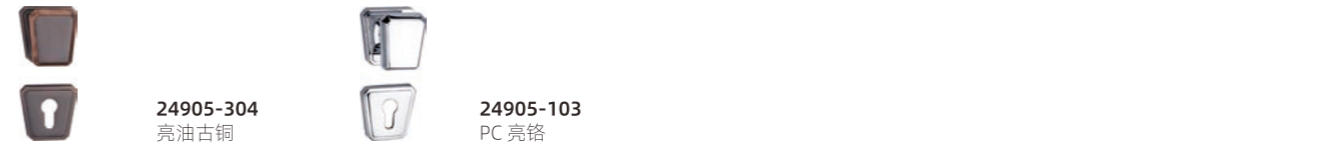
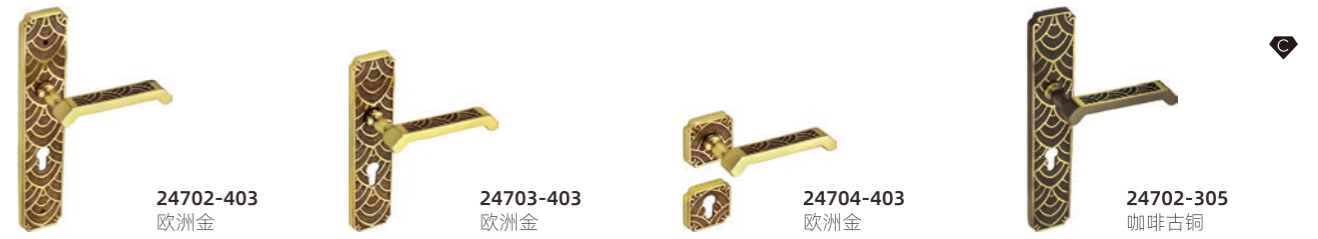
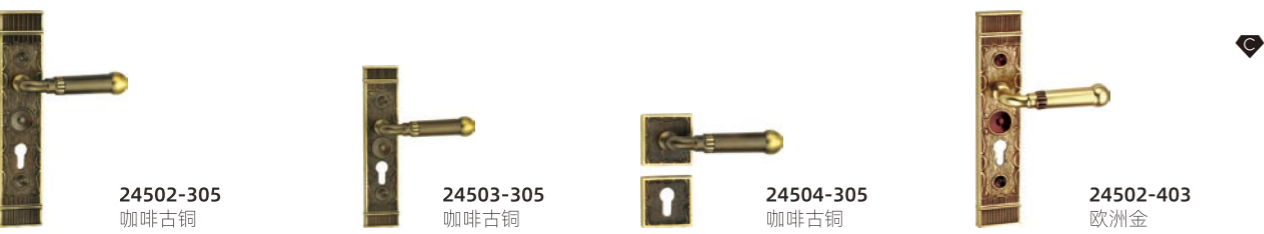
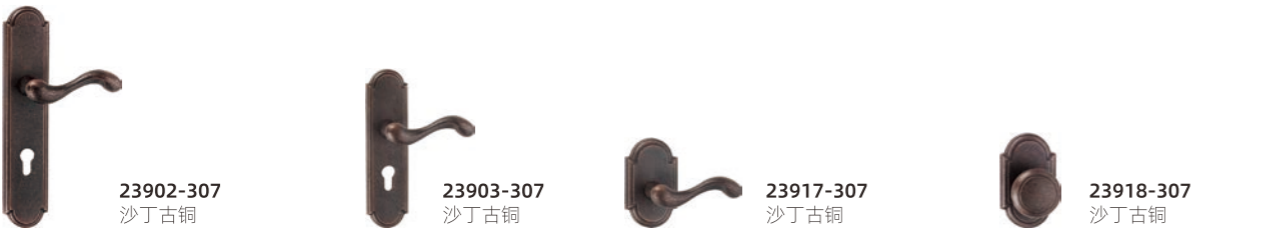
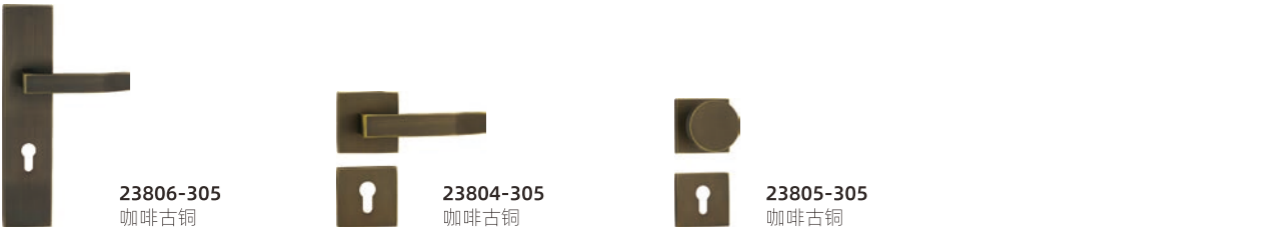

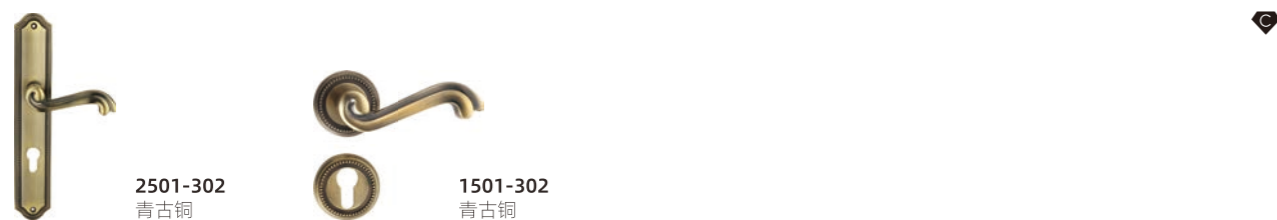
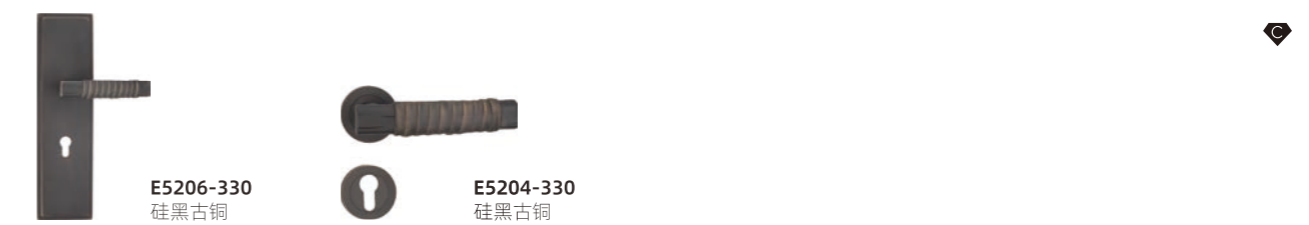
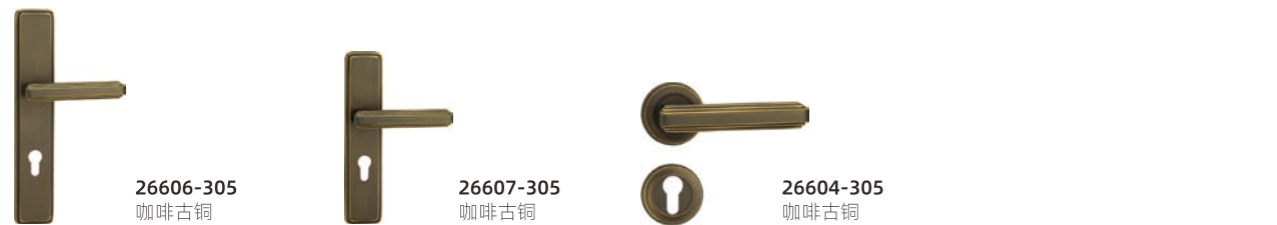
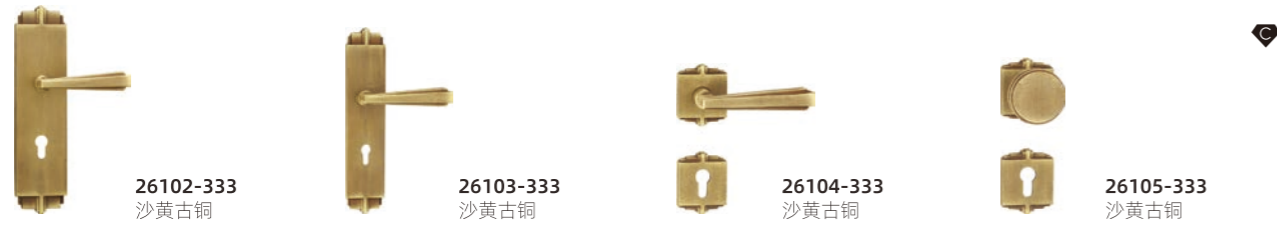

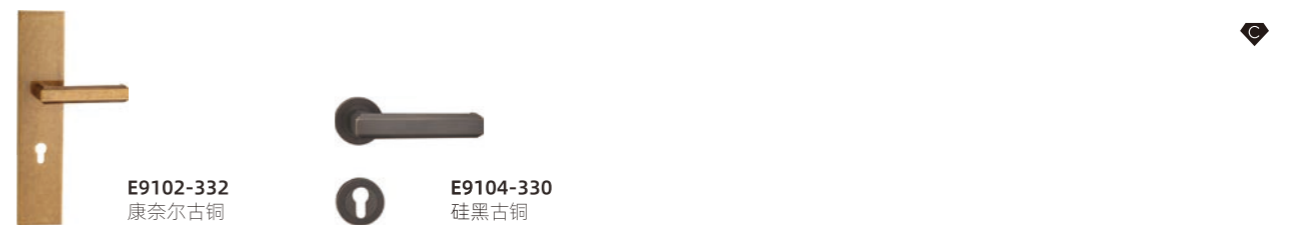
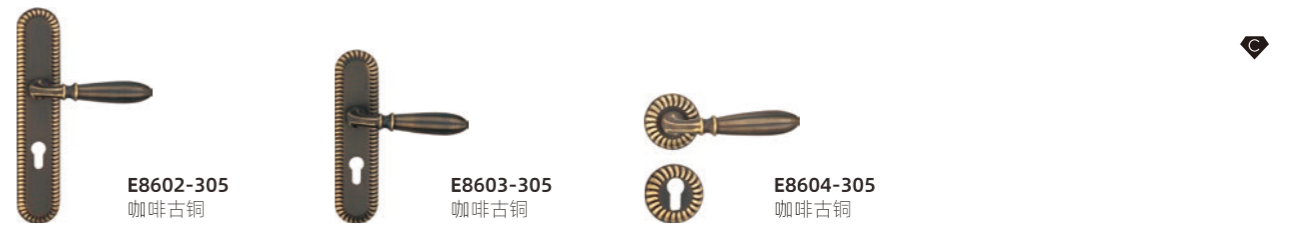
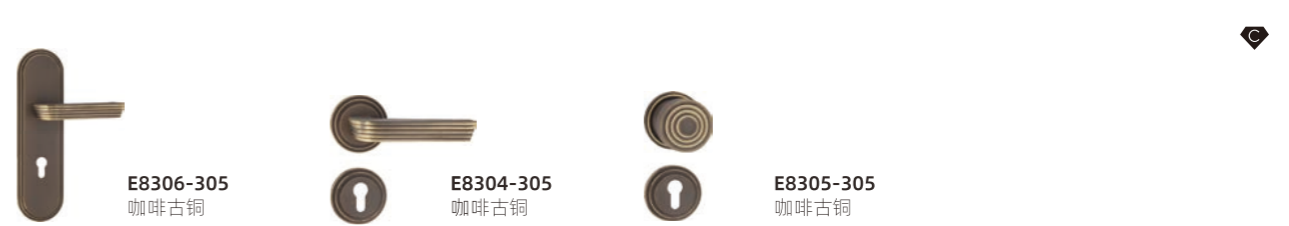
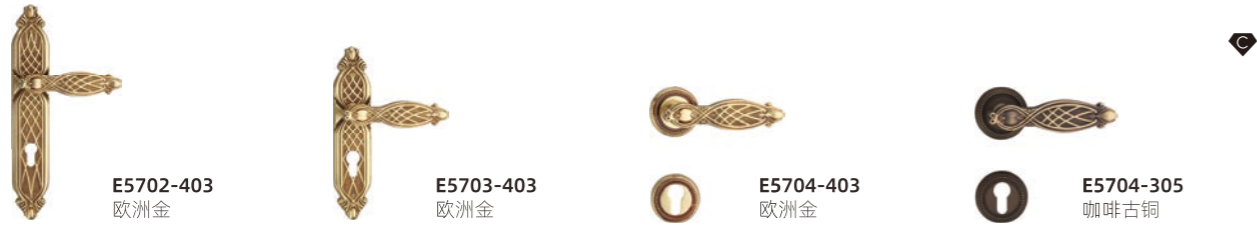

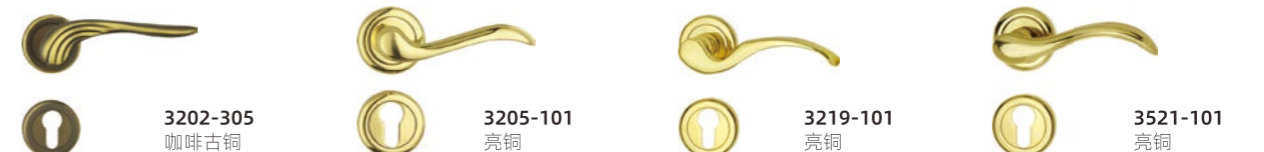
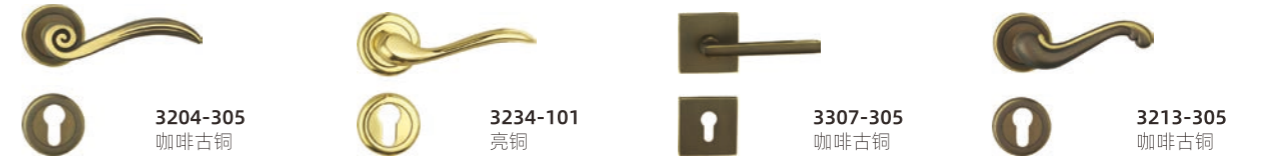

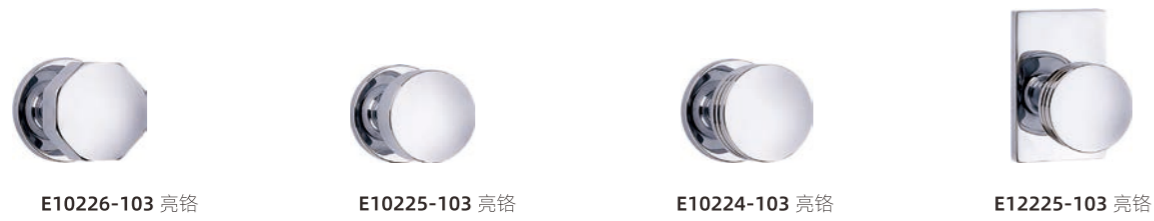



3206-303
油古铜



3206-101
亮铜



3208-310
古镍



3217-101
亮铜



3540-201
PVD



3625-101
亮铜



3651-101
亮铜



3653-101
亮铜



E10223-103 亮铬



L114651-301
黄古铜



L115653-104
铜拉丝



L115653-304
亮油古铜



L116206-301
黄古铜



L104625-118
欧洲铜



L107208-301
黄古铜



70210-403
欧洲金



70209-305
咖啡古铜



70200-305
咖啡古铜



70200-403
欧洲金



70204-304
亮油古铜



70203-305
咖啡古铜



70205-118
欧洲铜



70205-305
咖啡古铜



70207-101
亮铜



70208-330
硅黑古铜



AM 双开锁芯 -101 亮铜



AM 隐形门锁芯 -101 亮铜



AM 卫浴锁芯 -101 亮铜



AM 常规锁芯 -101 亮铜



AM 锁芯钥匙 -101 亮铜



花旋钮 亮铜

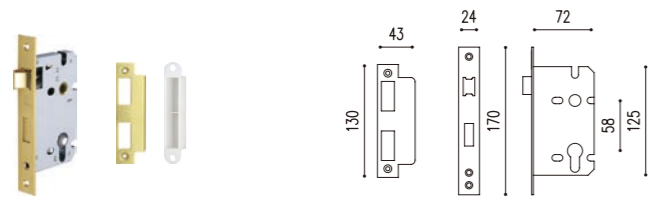

5850 表面处理
 门锁体
 门挡板
 门扣盒
 亮铜、沙丁古铜、铜亚青、亮铬、黑色、亮油古铜、镍拉丝
 适配：58 房门锁

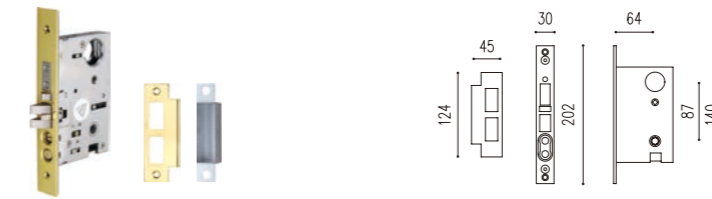

8764
 美标门锁体
 美标门扣板
 美标门扣盒
 适配：大门锁

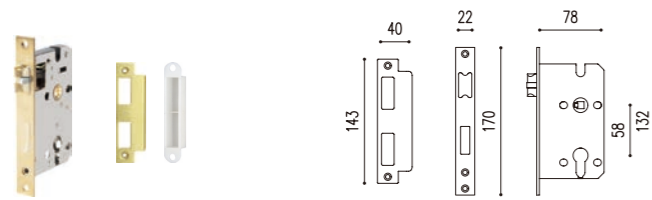

5850MX 表面处理
 门锁体
 门挡板
 门扣盒
 铜拉丝
 镍拉丝
 适配：58 房门锁

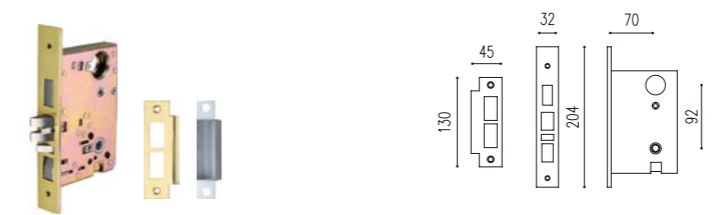

9270
 美标门锁体
 美标门扣板
 美标门扣盒
 适配：大门锁

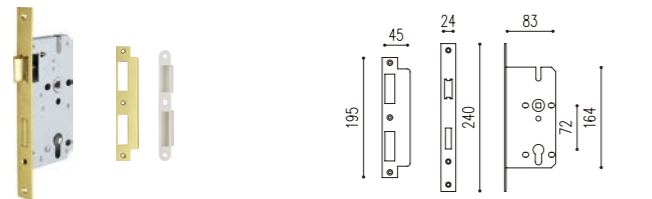

7255 表面处理
 门锁体
 门挡板
 门扣盒
 亮铜、深古铜、亮铬、黑色、亮油古铜、沙丁古铜、镍拉丝
 适配：72 房门锁

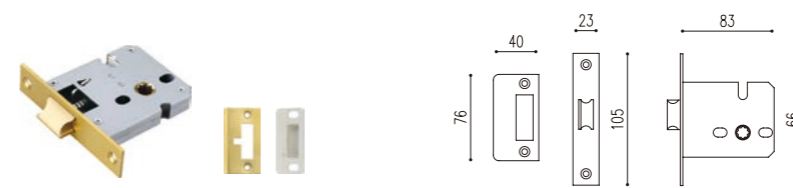

55C-2
 门锁体
 门扣板
 门扣盒
 适配：通道锁

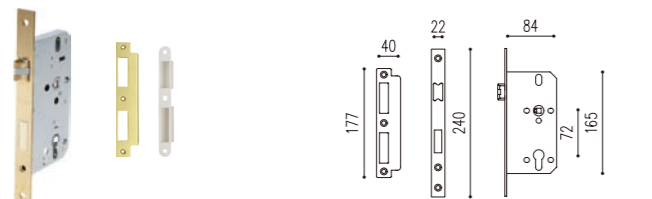

7255M 表面处理
 门锁体
 门挡板
 门扣盒
 黑色、铜拉丝、卡其灰、铜亚青、镍拉丝
 适配：72 房门锁

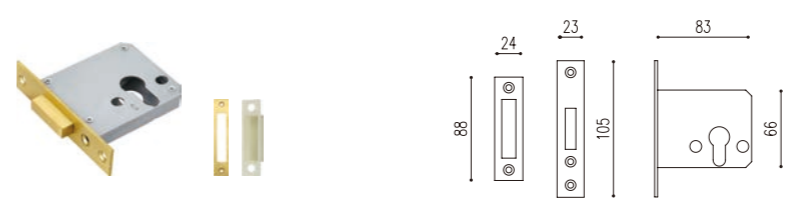

55F-2
 门锁体
 门扣板
 门扣盒
 适配：隐形门锁

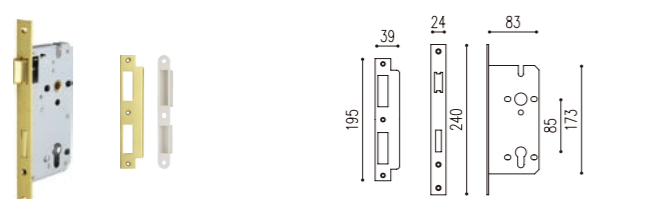

8555 表面处理
 门锁体
 门扣板
 门扣盒
 黑色、亮铜、铜亚青、深古铜、镍拉丝、沙丁古铜、亮铬
 适配：85 房门锁

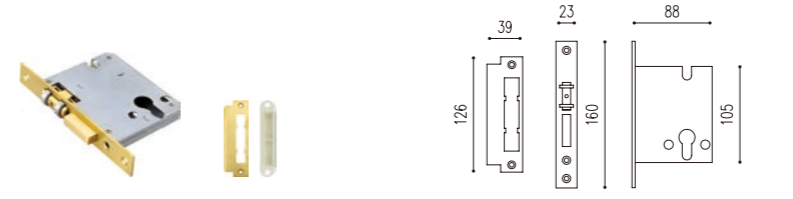

P60
 门锁体
 门扣板
 门扣盒
 适配：隐形门锁

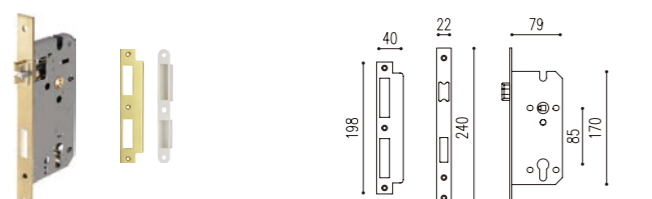

8550MX 表面处理
 门锁体
 门挡板
 门扣盒
 黑色、铜拉丝、铜亚青、镍拉丝
 适配：85 房门锁

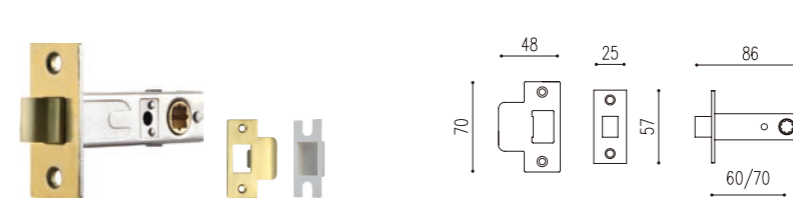

PL 60 70
 门锁体
 门扣板
 门扣盒
 适配：美式通道锁

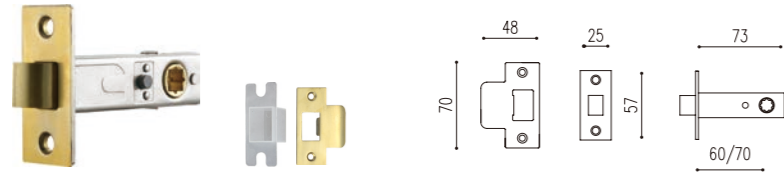

BL 6070

门扣盒
门扣板

适配：美式卫浴锁

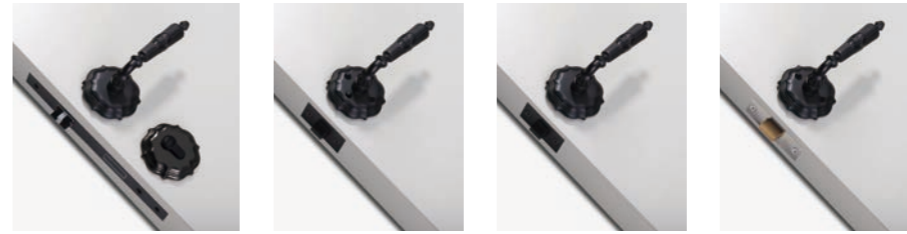

常规锁

美式卫浴锁

美式通道锁

美式隐形门锁

22806
亚黑



MB6070

门扣盒
门扣板

适配：美式锁



常规锁

卫浴锁

通道锁

隐形门锁

22305
亚黑



SL01

移门锁锁芯
移门锁锁体
移门锁门框扣板
移门锁锁扣盒
移门锁钥匙

适配：移门锁



常规锁

卫浴锁

通道锁

隐形门锁

22304
亚黑



常规锁

卫浴锁

通道锁

隐形门锁

E100-E028
亚丝金